

DIAPHRAGM DESIGN GUIDEBOOK



 **DIA.COM CORPORATION**
The Diaphragm Company
Online Guidebook: www.diacom.com

email: marketing@diacom.com Phone: 603.880.1900



Providing Superior Solutions to Tough Sealing Problems in:



Natural Gas



Automotive



Industrial



Aerospace



Consumer Products



Medical



Water Control & Irrigation



Food Processing

The information contained herein is believed to be reliable, but no representations, guarantees or warranties of any kind are made as to its accuracy, suitability for particular applications or the results to be obtained therefrom. Nothing contained herein is to be considered as permission, recommendation, nor as an inducement to practice any patented invention without permission of the patent owner.

Why Choose DiaCom Corporation?

Since its founding in 1983, DiaCom has been committed to a single goal: the design and production of the finest molded diaphragm seals available. Today, DiaCom is an industry-leading provider of innovative, cost-effective molded diaphragm solutions that are critical to the operation of essential equipment and systems in: Industrial, Automotive, Aerospace, Medical Instrumentation, Food and Water processing, and Gas Regulator/Gas Metering applications. Our reputation for solving the toughest sealing problems is based on our superior quality management system, our engineering expertise, and advanced manufacturing capabilities. DiaCom's commitment to quality is reflected in our latest AS9100 Certification in 2015 and ISO

9001 certification in 2016. We are constantly striving for continuous improvement. The AS-9100 standard implements a strong focus on product quality, process control, and product conformity to specification. By encompassing our Engineering expertise and advanced manufacturing capabilities, DiaCom is able to deliver engineered diaphragm solutions that are unsurpassed in performance. DiaCom uses our core expertise of bonding industrial fabrics, fluorinated films, plastics and metals to our custom engineered elastomers in a variety of molded parts including: fabric reinforced diaphragms, molded diaphragms, rolling diaphragms, diaphragm seals, chemical septums, bellows, accumulators, valve plungers and valve seats.

Molded Diaphragms - Ideal Solutions to Tough Sealing Problems:

The molded elastomeric diaphragm is a tough, versatile, dynamic seal that eliminates virtually all of the problems and limitations associated with other sealing methods such as U-Cups, O-Rings, metal bellows and flat, die-cut diaphragms. Unlike alternative techniques, molded diaphragms do not leak, offer no friction, have exceptional sensitivity, and display a hysteresis that is, in most cases, negligible. They can withstand pressures up to 6000 PSI over a temperature range of -65°F to 600°F, require no maintenance or lubrication, and are extremely cost-effective in most applications. DiaCom molded diaphragms are available in two forms: contoured, annular disks that provide high sensitivity and freedom of motion in short-stroke applications, and rolling diaphragms for frictionless, leak-proof sealing in cylinders and other applications requiring a long piston stroke.

The following molded diaphragm features ensure unmatched performance:

- *Minimum hysteresis – accurate, repeatable positioning*
- *No spring rate (rolling diaphragms)*
- *Long stroke length capabilities*
- *No lubrication*
- *No break-away or sliding friction*
- *Long cycle life*
- *Effective in harsh environments*
- *Constant effective pressure area*
- *Low assembly and associated hardware costs*

Table of Contents:

Diacom Rolling Diaphragm Theory	4
Glossary of Terms	5, 6
Diaphragm Design Formulas	6
General Hardware Information	7, 8, 9
Rubber to Metal Bonding	9
Teflon®/Elastomeric Diaphragm Seals	9
Diaphragm Life Design Considerations	10, 11
Bead and Groove Design Considerations	12, 13
Type F Diaphragms	14, 15
Type FC & FC Offset Diaphragms	16, 17
Type D Diaphragms	18, 19
Type DC Diaphragms	20
Type O and OA Diaphragms	21
Type OB Diaphragms	22
Type P Diaphragms	23
Type I & ID Diaphragms	24, 25
Typical Fabric Characteristics	26
Chemical Compatibility Table	27
The Diacom Advantage	28
Application Data Form	29

DiaCom Rolling Diaphragm Theory

Theory:

Figure 1 illustrates pressure reaction on the diaphragm. It can be seen that almost the entire pressure load is supported by the piston head, and only a small amount of the liquid or gas pressure is supported by the narrow convolution of the diaphragm. Also note in Figure 1 that the lines of unit pressure (acting in horizontal planes because they must be normal to the surface) force the diaphragm against the piston and cylinder sidewalls on that portion of the diaphragm in contact with the cylinder wall and piston skirt. The lines of force acting on that part of the diaphragm not in contact with the cylinder or piston skirt (the semicircular segment of the convolution) are shown in Figure 2. Each line of unit pressure (P_r) acts normal to the semicircular segment; thus any one of the pressure lines can be replaced by its horizontal and vertical component. The horizontal components, acting in opposition, cancel out each other.

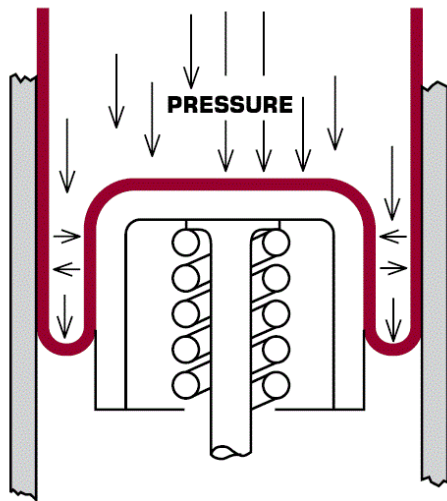

Figure 1

The sum of the vertical components of the unit pressures acting on this semicircular segment add up to the total pressure force (F) and is equal to the normal pressure on the projection of this segment.

Considering a unit (1 inch) of circumferential length of the diaphragm, the foregoing is:

1. $F = P_r \times 1 \times C$ or $F = P_r \times C$ where
 F = total pressure force (lbs.)
 P_r = normal loading or applied pressure (psi)
 C = convolution width (inches)

The total force F is supported equally by the fabric reinforcement of the diaphragm on the piston and cylinder wall (See figure 2). Therefore tension force, F_t (lbs.), in either wall is simply one-half the value of F or

2. $2F_t = F$ or $F_t = \frac{F}{2}$

However, as

3. $F = P_r \times C$ then
4. $F_t = \frac{P_r \times C}{2}$

Where F_t is the tension force on the diaphragm sidewall for each unit of circumferential length. Since tensile force F_t and fabric stress S_f are identical, equation 4 can be expressed in terms of fabric stress:

5. $S_f = \frac{P_r \times C}{2}$ where
 S_f = fabric stress (lbs. Per inch)
 P_r = normal loading or applied pressure (psi)
 C = convolution width (inches)

Fabric stress can be computed using equation 5. For example, if a 3-inch diameter diaphragm with an effective pressure area of 6.35 sq. in. and a convolution width of .156 is subjected to a loading pressure of 100 psi, the resulting total thrust is 635 lbs. However, fabric stress on the narrow convolution is only:

6. $S_f = \frac{100 \times .156}{2} = 7.8$ lbs. Per inch

Fabric materials are available in tensile strengths greater than 7.8 lbs. Per inch. Therefore, the very narrow convolution widths with resulting low stress values in the fabric fibers enable diaphragms to be used in applications involving high working pressures. In effect, DiaCom Rolling Diaphragms are pressure vessels having a variable volume

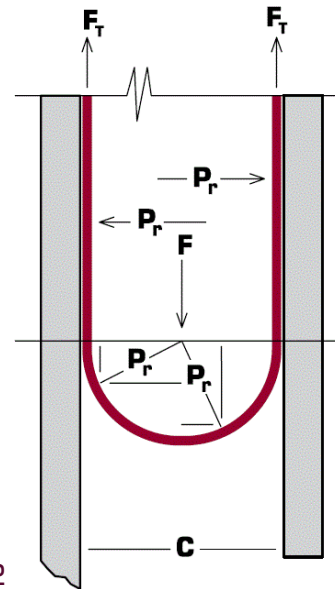

Figure 2

and flexible moving sidewalls. As in any other pressure vessel, its strength should be considered with respect to safety factors. Generally, diaphragms can be designed with a large safety factor. In effect, this means the maximum safe working pressure will be a fraction of the pressure that would cause failure in the convolution area. (In some aircraft applications where working pressures are as high as 1000 psi, and total cycle requirements are low, safety factors are substantially increased.) Actual stress analysis and selection of fabrics will be recommended by the DiaCom engineering department for each application.

Hardware:

Convolution Width – The clearance between the cylinder wall and piston skirt. By decreasing the convolution width, higher working pressures may be achieved. Generally, the convolution width should measure at least four times the diaphragm’s sidewall thickness. *(See page 7 for standard convolution widths.)*

Cylinder Diameter (Bore) – The inside diameter of the cylinder into which the diaphragm will fit and by which the outside diameter of the convolution will be supported.

Cylinder Radius – The blend radius between the cylinder wall and the flange.

Piston Cap – A plate which attaches to the piston, sandwiching the piston area of the diaphragm insuring the diaphragm stays in convolution.

Piston Diameter – Diameter of the piston measured across piston head, including radius.

Piston Radius – The blending radius between the piston head and the piston skirt.

Piston Skirt – The sidewall area of the piston which supports the inside diameter of the convolution

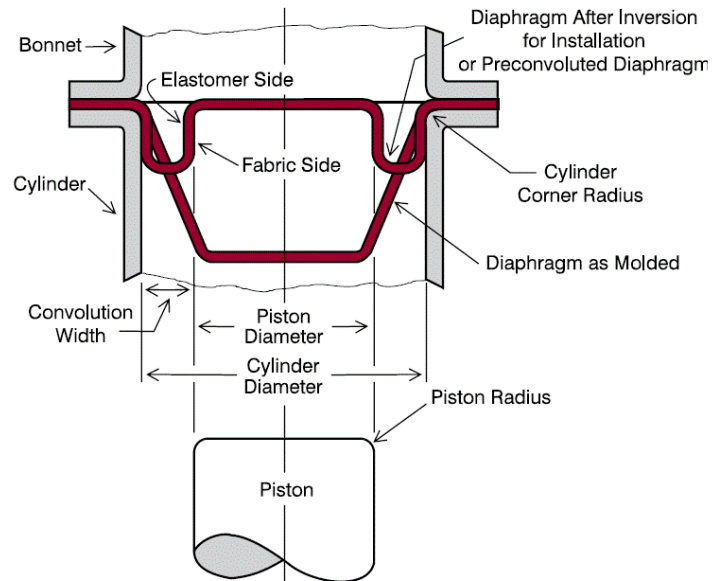

Diaphragm:

Cylinder Diameter – The diameter across the diaphragm between the tangent points of the sidewall and cylinder radius. Measured on the fabric or low pressure side of the diaphragm.

Fabric Side – Surface of single coat diaphragm where fabric is visible. Always on low pressure side, generally on outside of diaphragm.

Height – The height of top hat and preconvoluted diaphragm is measured from the bottom of the flange to the top of the head or convolution.

Piston Diameter – The diameter across the diaphragm between the tangent points of the sidewall and piston radius. Measured on the fabric or low pressure side of the diaphragm.

Preconvoluted – A diaphragm which has its convolution molded in. No hand forming is necessary before installation.

Sidewall – That area of the diaphragm between the flange and piston areas.

Top Hat – A diaphragm molded in standard “hat” shape that must be formed into convolution before installation

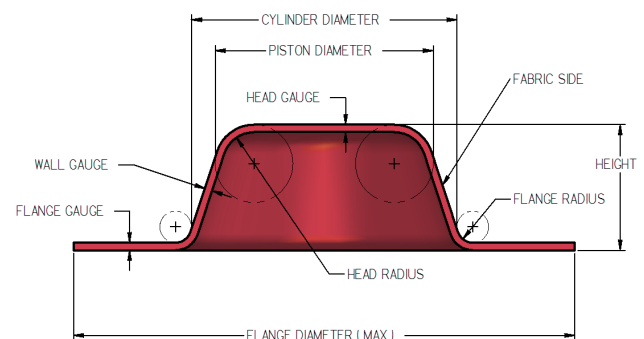

Top Hat Diaphragm

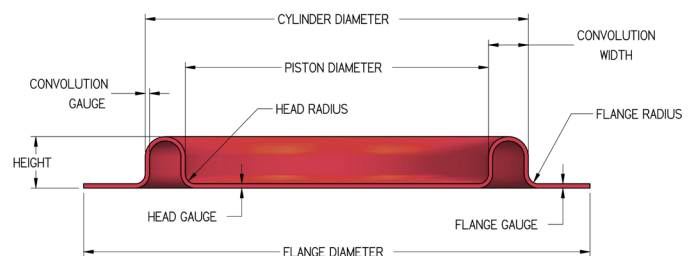

Preconvoluted Diaphragm

Glossary of Terms (continued):

Bleed-through – A defect in a diaphragm caused during manufacturing where the fabric is pulled through the rubber to the high pressure side of the diaphragm. When pressure is put on the diaphragm, the rubber will be blown away from the fabric and rupture.

Blow-through – Occurs when the pressure on the diaphragm reaches a level high enough to blow a piece of the rubber through the threads of the fabric, causing a leak. This is the result of selecting a weave of fabric that is too open for the diaphragm's thickness.

Double Coat – Diaphragm construction where the fabric is inserted between two layers of rubber.

Effective Pressure Area – The area of the diaphragm inside of an imaginary circle to the convolution midpoint on which the pressure introduced is transmitted to the opposite side of the diaphragm.

Over-stroke – Exceeding the designed stroke of the diaphragm causing it to come out of convolution. This can be avoided by designing mechanical stops into your hardware.

Reverse Pressure – When the pressure on the low pressure side of the diaphragm exceeds the pressure on the high pressure side of the diaphragm. This will cause the convolution to collapse and wrinkle. This wrinkle will cause scrubbing and lead to premature failure.

Single Coat – Diaphragm construction where there is rubber on the high pressure side and fabric on the low pressure side.

Spring Rate – The forces caused by the rubber trying to return to its as-molded position. This is generally only found in preconvoluted and dish-shaped diaphragms.

Strike-through – The amount of rubber that comes through the fabric to either fully or partially encapsulate the fabric during manufacturing.

Diaphragm Design Formulas:

Burst Pressure (psi)	=	$\frac{\text{Fabric Tensile Strength} \times 2}{\text{Convolution Width}}$
Effective Pressure Area	=	$\pi \left(\frac{\text{Piston Diameter} + \text{Cylinder Diameter}}{4} \right)^2$
Fabric Tensile Required	=	$\frac{\text{Convolution Width} \times \text{Burst Pressure}}{2}$
Half-Stroke (Preconvoluted)	=	$2 \times \text{Height} [2 (\text{Flange Radius}) + \text{Convolution Width} + 2 (\text{Flange Gauge})]$
Half-Stroke (Top Hat)	=	$\text{Height} - [\text{Flange Gauge} + 2 (\text{Flange Radius}) + 1.56 (\text{Convolution Width}) + \text{Safety Factor}^*]$
Height (Pre-Convoluted)	=	$1/2 [\text{Convolution Width} + 2 (\text{Flange Radius}) + 2 (\text{Flange Gauge}) + \text{Half-Stroke}]$
Height (Top Hat)	=	$\text{Half-Stroke} + [\text{Flange Gauge} + 2 (\text{Flange Radius}) + 1.56 (\text{Convolution Width}) + \text{Safety Factor}^*]$
Piston Skirt Length	=	$\frac{\text{Height} + \text{Half-Stroke}}{2}$
Safe Working Pressure (psi)	=	$\frac{\text{Burst Pressure}}{4}$

(Note: Please See Page 26 for Fabric Tensile Strength)

Cylinder Diameter	.33 - .99	8.38-25.15	1.00 - 2.5	24.50 - 63.50	2.51 - 4.00	63.75 - 101.60	4.01- 8.00	101.85 -203.20
* Safety Factor	.060	1.52	.100	2.54	.120	3.05	.140	3.56

General Hardware Information:

Diaphragm Strokes:

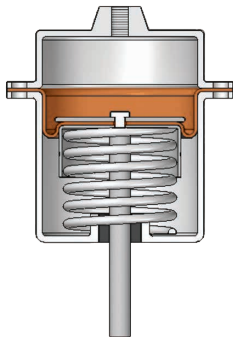

Down-Stroke Position

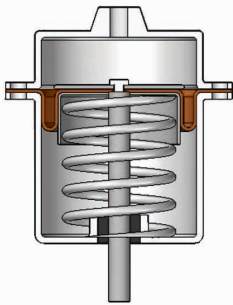

Neutral Plane Position

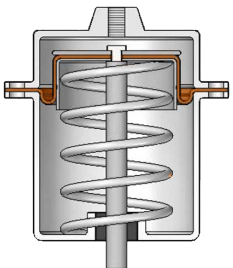

Up-Stroke Position

Piston and Standard Convolution Width Dimensions:

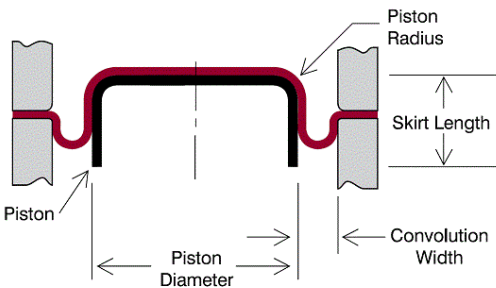

Diaphragm Cylinder Diameter	Piston Skirt Length 'Top Hat'	Piston Skirt Length 'Pre-Convolution'	Piston Radius	Standard Convolution Width
.37 to .99	9 to 25	$\frac{\text{Height} + \text{Half Stroke}}{2}$.0312	0.80
1.00 to 2.50	25 to 64	$\frac{\text{Height} + \text{Half Stroke}}{2}$.0625	1.59
2.51 to 4.00	64 to 102	$\frac{\text{Height} + \text{Half Stroke}}{2}$.0937	2.38
4.01 to 8.00	102 to 205	$\frac{\text{Height} + \text{Half Stroke}}{2}$.125	3.18

Piston Cap Dimensions:

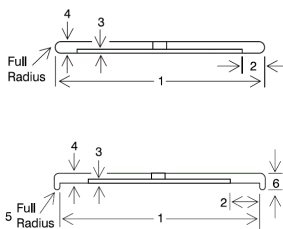

Diaphragm Cylinder Diameter	1	2	3	4	5	6
.37 to .99	9 to 25 Piston + 2 (Diaphragm Thickness)	Not Required	Not Required	Not Required	.063	1.59
1.00 to 2.50	25 to 64 Piston + 2 (Diaphragm Thickness)	.15 x Piston Diameter	.010	0.25	0.94	2.39
2.51 to 4.00	64 to 102 Piston + 2 (Diaphragm Thickness)	.15 x Piston Diameter	.015	0.38	.109	2.78
4.01 to 8.00	102 to 205 Piston + 2 (Diaphragm Thickness)	.15 x Piston Diameter	.015	0.38	.125	3.18

Bonnet Dimensions:

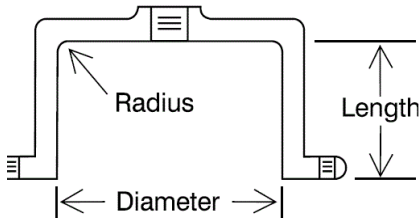

Cylinder Dimensions:

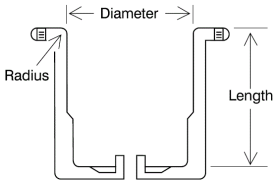

Minimum Cylinder Diameter	Length	Maximum Radius
Piston Diameter + 8x (Diaphragm Gauge)	Diaphragm Upstroke	$\frac{\text{Convolution Width}}{2}$

Diaphragm Cylinder Diameter	Length	Radius
.25 to .99	60 to 25	Down-stroke + Piston Skirt
1.00 to 2.50	25 to 64	Down-stroke + Piston Skirt
2.51 to 4.00	64 to 102	Down-stroke + Piston Skirt
4.01 and up	102 and up	Down-stroke + Piston Skirt

General Hardware Information

Flange Retention Methods for Type F, FC & I Diaphragms:

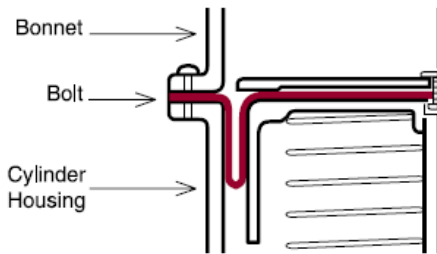

Most common flange retention method. Bolt holes should be at least 15% larger than the bolt. Allow sufficient number of bolt holes to eliminate bowing or distortion of flange, providing a tight seal and preventing the diaphragm flange from pulling out between the bolts.

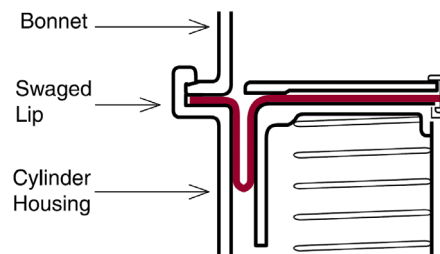

Lending itself to high volume/low cost, the swaged lip resembles the crimp ring in design except that the lip is an integral part of the cylinder or bonnet. Lip should be flexible and thin to insure proper flange retention.

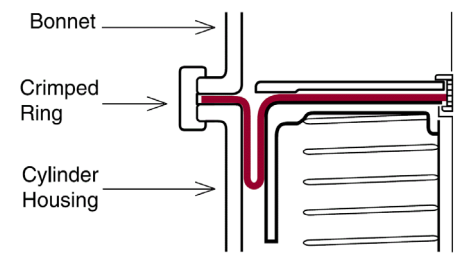

This method lends itself to high volume and low cost manufacture. It utilizes a separate metal crimp ring and is assembled to unit with special crimping tools. These crimp rings are made of thin, ductile materials so that the force required to form the lip will not over-compress the diaphragm flange area.

Flange Retention Methods for Type D, DC, & ID Diaphragms:

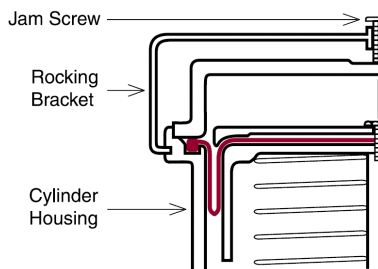

Provides quick assembly and disassembly. The pivoted rocking bracket is attached to the housing flange and the central jam screw secures the bonnet against the mating flange.

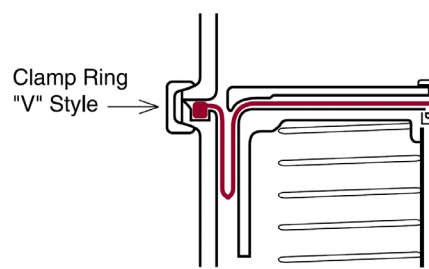

"V" style clamp rings can be disassembled quickly by removing a clamp lever. A retainer plate is removed by turning it 90 degrees where two "wings" and a retaining screw drop into a keyhole.

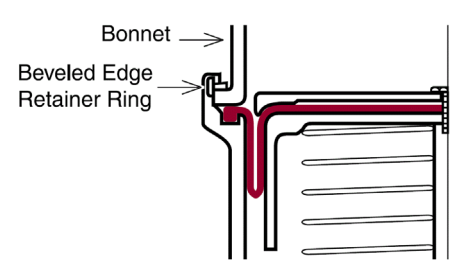

Eliminates the need for flange bolts as a beveled edge ring is snapped into a groove in the extension of the cylinder housing flange. This loads the bonnet assembly onto the mating bead, generally producing low clamping forces.

Flange Retention Methods for Type O and OA Diaphragms:

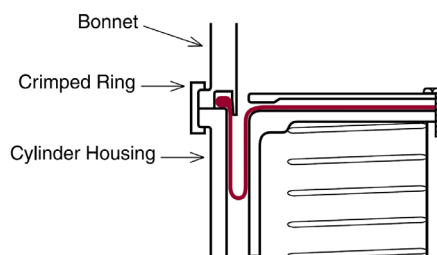

Used in high volume, low cost applications, this method eliminates typical flange construction and flange bolts.

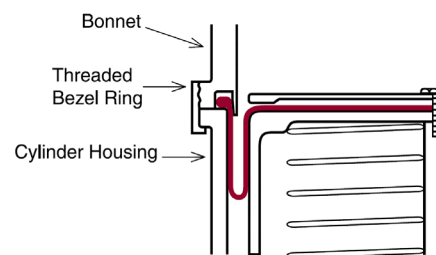

This common method provides minimum clearance of the housing outside diameter. Male threads are machined on the cast bonnet to utilize drawn sheet metal cylinder housings, reducing costs.

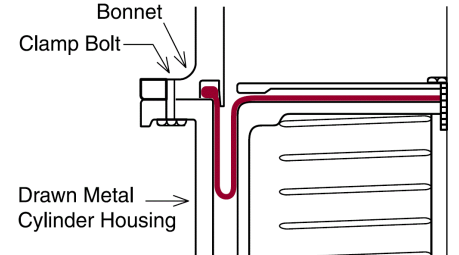

This method requires sufficient number of circumferential clamp bolts so distortion does not occur between flange bolts. It is advisable to make provisions for the bead groove in the cast or molded bonnet.

Rubber to Metal Bonding:

DiaCom has capabilities to bond metal or plastics to diaphragms during the molding process. Mechanical bonding is generally the least expensive and simplest method to achieve. This process is accomplished by designing the insert with projections or holes. During the molding process the insert becomes totally or partially encapsulated by the elastomer creating a strong mechanical interlock. Figure 1 illustrates a mechanical bond.

Chemical or adhesive bonding utilizes a commercial adhesive applied to the non-elastomeric component. The component is then attached to the elastomer during or after vulcanization depending on the type of bond required and geometry of the diaphragm. Figure 2 illustrates an adhesive bond.

When designing the metal insert it is recommended to avoid sharp projections extending into the elastomer or sharp corners at the junction line between the two materials.

Steel is the most prevalent insert material used but brass, stainless steel, aluminum, and nylon are also used. Certain elastomers and insert materials can also develop a cohesive bond through molecular attraction. This is most commonly accomplished with the use of brass and a sulfur-cured nitrile.

By bonding inserts to diaphragms, costly assembly operations can be reduced or eliminated. Additionally, rivet, screw or other fastening methods which might create leak-paths through the diaphragm would be eliminated with a bonded insert.

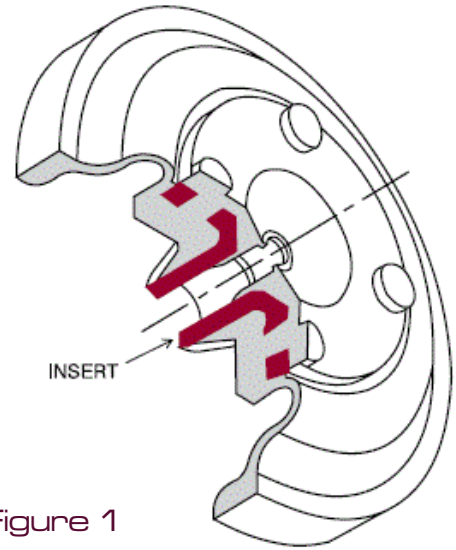

Figure 1

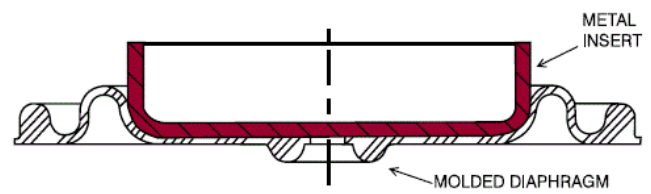
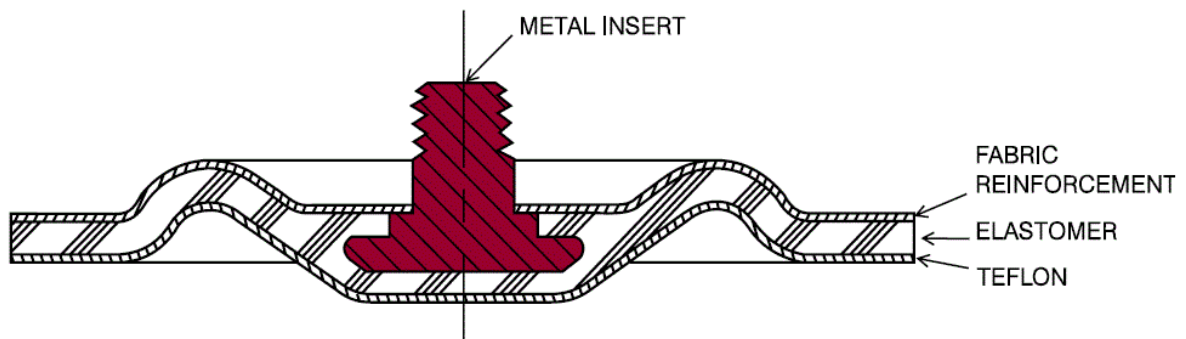

Figure 2

Teflon®/Elastomeric Seals:

DiaCom has capabilities to design and manufacture composite diaphragms made from TEFLON®/ELASTOMERIC MATERIALS. DiaCom's process bonds TEFLON® to rubber using TEFLON® as thin as .002" thick. DiaCom's unique process

and construction produces a diaphragm that is compatible with harsh environments without limiting the life and responsiveness of the diaphragm. For additional strength, fabric may be added to the Teflon®/Elastomer composite.



Benefits of Teflon®/Elastomeric Diaphragms include:

- Excellent Chemical Resistance
- Low Permeation Rate
- Temperature Extremes (-450/400 degrees F)
- Low Co-Efficient of Friction
- FDA Approved Materials

(Teflon® is a registered Trademark of the DuPont Corporation)

Diaphragm Life Design Considerations:

When designing a diaphragm, a prime consideration is what can be done to extend the life of the part. The factors that contribute the most to early failure of a diaphragm are; **sharp edges, abrasion, back pressure, and circumferential compression**. The first step is in the hardware design itself.

The obvious considerations are the elimination of burrs and sharp edges that may come in contact with the diaphragm. These flaws will cut and tear at both fabric and elastomer resulting in premature failure.

Not so obvious is the finish of the hardware. When pressure is constantly applied then relieved the diaphragm does rub against the supporting hardware. If the surface of the hardware is rough, it can abrade the fabric causing an earlier than expected failure. It is recommended that these surfaces be no rougher than **32 micro inches** and if necessary be finished to 16 micro inches in higher cycle applications. Although

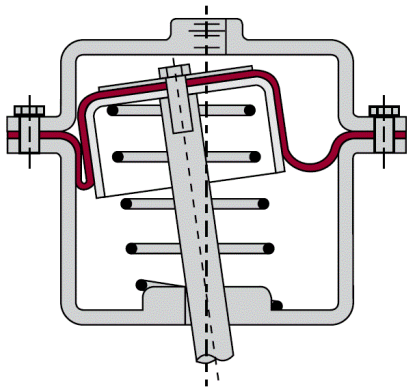

Cocked Piston

diaphragms do not require lubrication they may be coated with a molybdenum disulfide prior to installation to aid in the reduction of abrasive wear. The piston may also be coated with Teflon to reduce friction when the diaphragm shifts against it, or with an elastomer coating which will prevent the diaphragm from shifting resulting in the elimination of abrasion.

The quickest failure occurs when the sidewall of the diaphragm comes in contact with itself. When this happens the two rubber surfaces lock together while the piston continues to travel. This generally results in the sidewall of the diaphragm being jammed between the piston and cylinder wall with the elastomer and fabric torn. There are generally two causes for this. The first is the **alignment between the piston and cylinder**. There is usually no problem at high pressure where the pressure itself equalizes on the diaphragm helping to center the piston. However, at low pressure gravity can take over and pull the piston to one side causing a problem. This can be avoided with a bushing for the piston or some other way of keeping the piston centered throughout its stroke.

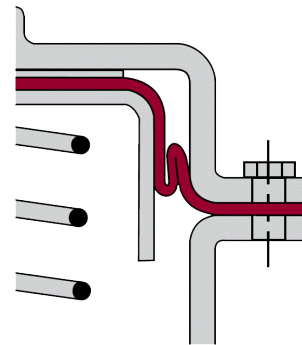

Reverse Pressure

The second cause of this type of failure is **back-pressure**. Generally, diaphragms can only take a high differential in one direction. If the pressure gets higher on the low pressure side of the diaphragm the sidewall collapses causing failure. The problems with **back-pressure** usually occur when the user is unaware that it even exists. Since most diaphragm applications are in closed actuators there must be a means to adjust for the change in gas or fluid volume above and below the diaphragm as it is stroked up and down. This is usually not a problem on the high pressure side of the diaphragm since the change in volume here is what is counted on for the apparatus to operate and perform its function. The problem occurs on the low pressure side where the volume of gas or fluid must be removed and replaced with each stroke of the diaphragm. Vent holes must be sized correctly to allow enough volume to pass through in the amount of time it takes to stroke the diaphragm. It is also important to remember this when actuation sequences are increased during accelerated testing or simply faster cycling of your device.

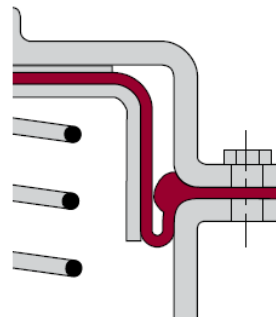

Over Clamping

Another cause of failure is **over-clamping** the diaphragm in the hardware during assembly. For the diaphragm to seal properly, compression of the diaphragm material is expected and required. Care must be taken, however, as rubber material will act as an incompressible fluid and your design must allow for this condition. With proper diaphragm design and assembly techniques, this condition is not a concern. If over-clamping exists, the rubber material may bulge into the working area of the diaphragm, precipitating early diaphragm failure.

Observing prudent guidelines can greatly extend service cycles:

The final cause of failure is **circumferential compression**. This is a term used to describe the larger diameter sections of the diaphragm sidewall being compressed around the piston. As seen in the diaphragm sketches below, a ring section of material in view A is larger in diameter than the same ring section in view B. In view A, the diaphragm is rolling onto the cylinder wall while in view B, the diaphragm is rolling onto the piston skirt. It appears that the ring of material is smaller when the diaphragm is rolling onto the piston skirt.

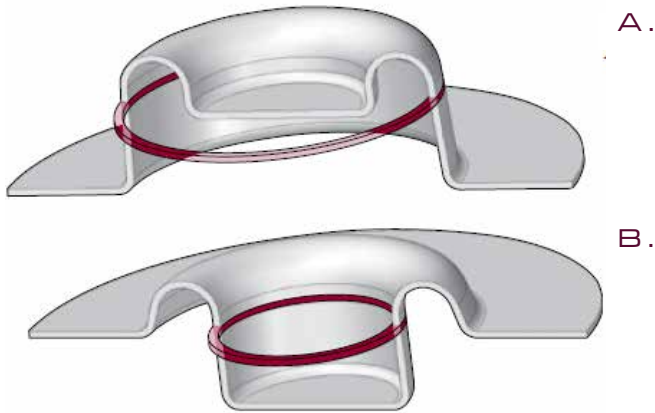

In actuality, the ring of material doesn't vary in size. As the ring of material rolls onto the piston, it forms an axial fold in the sidewall, allowing the diaphragm to conform to the piston. Because the fabric used for support has a square pattern the folds occur at the four points that the warp and fill threads are perpendicular to the convolution. This condition can be seen in the sketch below which shows a top view of the ring of material when the diaphragm has rolled onto the piston. This condition is most often referred to as "**four-cornering**" and is not something that can be eliminated but rather controlled. The continuous folding at the same location eventually leads to a break in a cross thread leading to a rupture of the elastomer. There are several ways to reduce this circumferential compression.

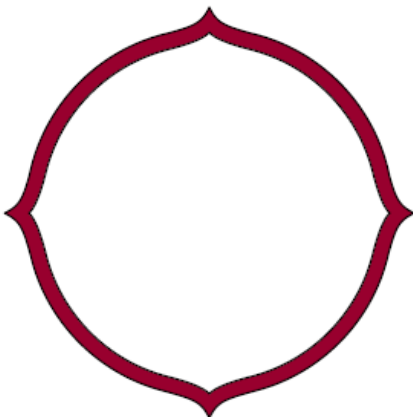

Four -Cornering

The first is to only use the bottom half of the diaphragms stroke. Using the bottom half of the stroke limits the section of the sidewall that must be compressed around the piston to the top. This is the section of the sidewall with the smallest circumference difference with the piston which means the folds will be smaller and not as sharp. The result of this is longer diaphragm life. Another way to accomplish this and still keep the total stroke capability of the diaphragm is the **double-tapered diaphragm**.

A. On a standard top hat diaphragm the sidewall of the diaphragm is a straight line tangent to the flange and piston radii. On a double tapered top hat the sidewall is a line tangent to the cylinder radius running at a 45 to 60 degree angle to a point approximately 60% of the way through the convolution width. At this point it wraps around a small radius then straight to a point tangent to the piston radius. This makes the sidewall at a much steeper angle for the usable length of the sidewall which in turn reduces the circumference. The same effect can be obtained in a preconvoluted diaphragm by molding the diaphragm as an offset preconvoluted diaphragm. Basically, this is a preconvoluted diaphragm molded in the full up position. This puts the total amount of working sidewall at the piston circumference virtually eliminating circumferential compression.

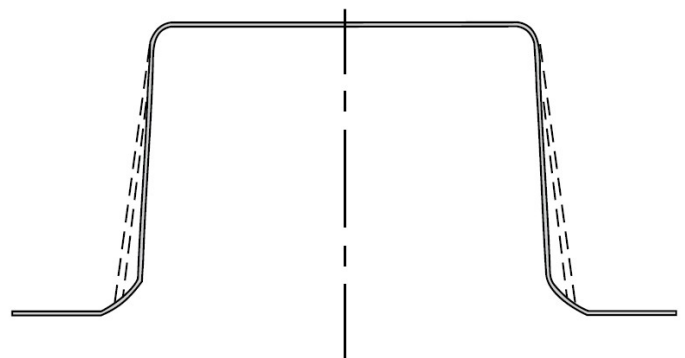

Double-Tapered Diaphragm

The final means of reducing the circumferential compression is with a tapered piston. This simply increases the piston circumference as the sidewall circumference increases. This is probably the least desirable means to solving the problem because while adjusting the circumference helps it also decreases the effective pressure as the pressure decreases and tightens the convolution width as the pressure increases. Both of these effects must be considered and tested before this solution is used.

Bead Design Considerations:

A simple and effective solution, but fit must be precise...

One of the most popular flange designs in diaphragms is the Beaded Type. This style of flange enables the designer to control the amount of squeeze applied to the diaphragm's flange without concern for the amount of force applied to the flange during assembly. Controlling this squeeze avoids the three most common types of premature failures; 1.) Not enough squeeze resulting in flange leakage, or 2.) Over squeezing the flange and cutting the diaphragm or 3.) Flowing the elastomer into the working area of the diaphragm causing the diaphragm to distort and fail prematurely. These benefits can be lost if the bead and the bead groove are not designed in conjunction with each other.

Figure 1

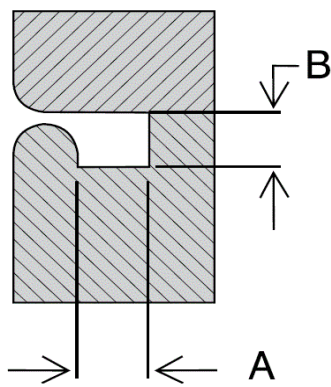

The first consideration is how much to deflect the rubber to effect a seal. This number may change for some compounds but generally we recommend a minimum of 20% deflection of the elastomer (B dim Fig.1). This number insures that the seal will be maintained even after the elastomer takes its compression set. Since the flange thickness and the hardware dimensions need tolerances, the design should be calculated at 25% +/- 5%. This generally is enough to allow for normal tolerancing of the hardware to insure a good seal. However, there are those situations where the variation in elastomer thickness, or hardware dimensioning is such that it is impossible to keep everything in the range to maintain the 20% to 30% deflection. In cases such as these we recommend that the deflection exceeds the 30% rather than go below the 20%.

The key point that must be remembered when designing a bead and bead groove is that the elastomer is incompressible. When you deflect it 25% to form a seal the elastomer needs a place to go. If you haven't provided that room in the groove area of your hardware, then the elastomer will flow out of the groove into the working area of the diaphragm. This can cause cracking in the flange radius area of the diaphragm or enough distortion in the diaphragm to cause the two sidewalls to come together, resulting in failure. To avoid these problems, simply design your bead groove so that when the hardware is assembled the volume of the groove is such that it can contain the largest bead the spec will allow (A, Fig.1).

Figure 2

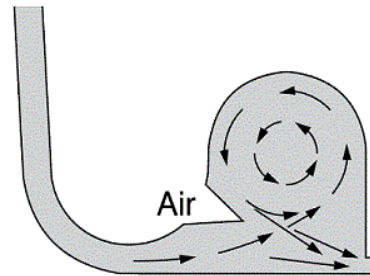

Another point to consider when designing beads on diaphragms is to make them as manufacturable as possible. This will insure a better product as well as more price stability. The main problem experienced in the manufacture of beaded diaphragms is air entrapment. This "trapped air" displaces elastomer in the bead resulting in a reduction of bead volume. Generally, air entrapment is not a problem on standard "D-Bead" parts where the fabric is on the same side of the part as the bead. The reason for this is that the fabric acts as a leak path out of the mold for the air, enabling the elastomer to completely fill the bead area.

However, when there is no fabric in the bead as in a homogeneous part or one that the bead is designed onto the elastomer side of the diaphragm there is no way of insuring that all the air will be forced out of the bead. This is due to the fact that the bead's geometry prevents the elastomer from moving in a straight path (Fig. 2) keeping the air in front of it. To solve this problem we recommend moving the parting line to the opposite side of the bead (Fig. 3). This enables the elastomer to move in a straight path keeping all the air in front it and insuring that the volume and height of your bead remain constant. There are no special bead groove requirements for this because there is no increase in volume of elastomer. It is important to remember that you are obtaining the seal by deflecting the bead from top to bottom, not side to side.

Figure 2

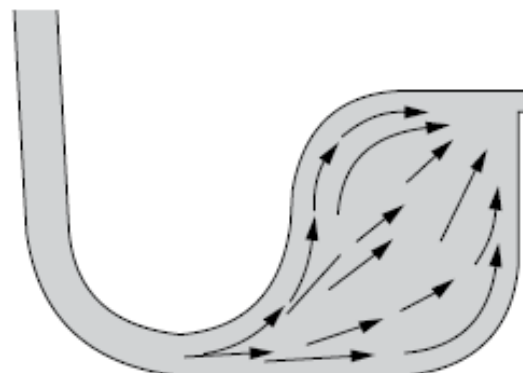

Beads can be added to the diaphragm in an almost infinite variety of shapes and sizes. However, there are many things to consider before adding beads to the diaphragm design, not the least of which is the impact on the cost of the diaphragm. Most beads are added to a diaphragm to be used as the sealing mechanism in the final application.

Beads are formed during the molding operation by flowing rubber into the mold cavity, filling the bead area while driving

out the air. There are several limitations on bead design that must be considered due to this rubber flow. Bead location, shape, size, mold parting line, must all be carefully considered. The examples below illustrate some of the changes that can improve the quality of the diaphragms. These design changes are often driven by the location of the fabric reinforcement (the location of the fabric is shown below by the (F) symbol), but these design recommendations also apply to homogeneous (all-rubber) as well as double-coated diaphragms.

As Designed

Recommended

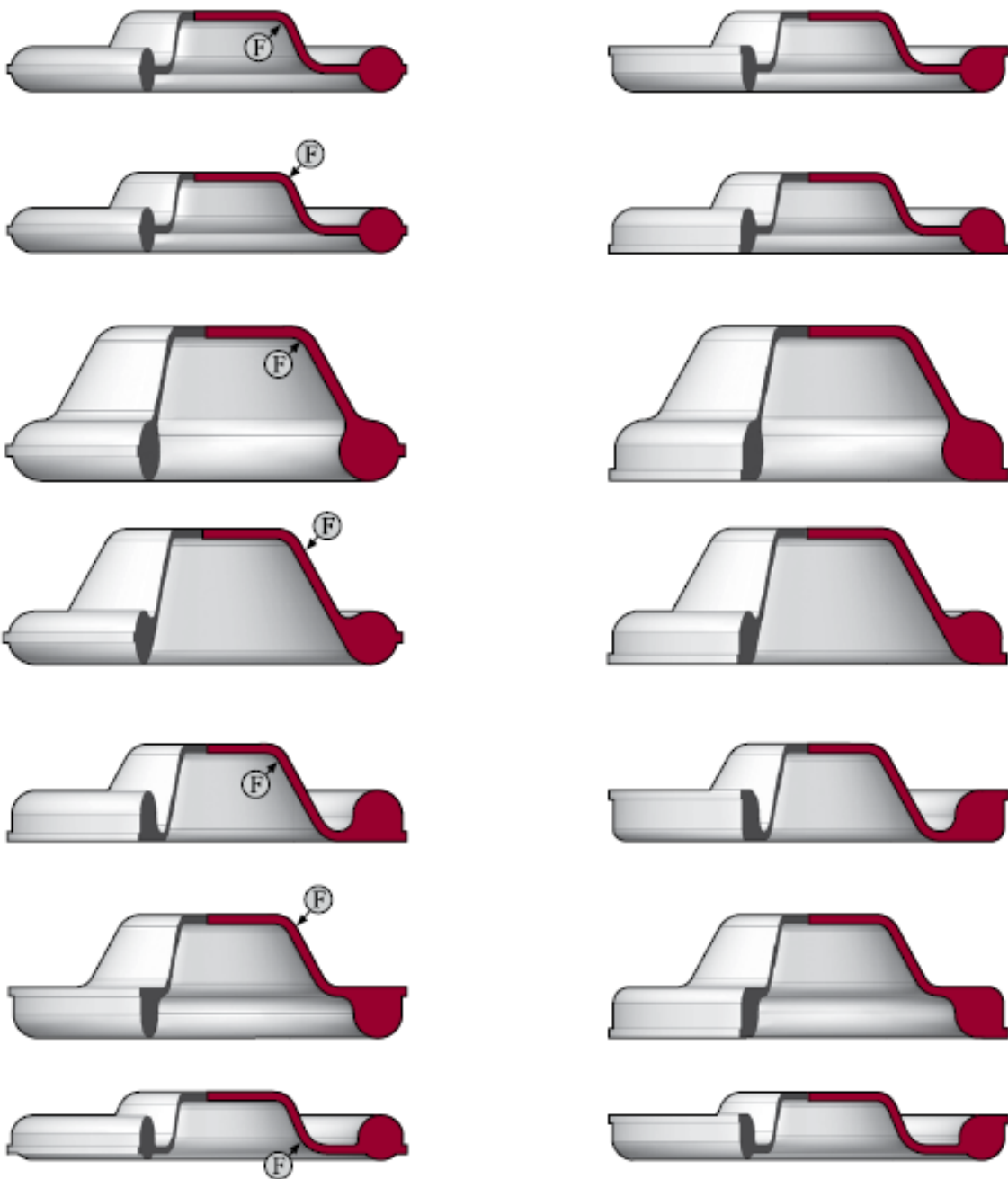

Type F Diaphragms

General Description:

The Type F is commonly referred to as the “top hat” diaphragm (Figure 2). It exhibits all of the benefits that are associated with rolling diaphragms. These diaphragms have the longest stroke-to-bore ratio, zero spring rate, no break away friction, constant effective pressure area, and long life. Some of the drawbacks to Type F diaphragms are: additional assembly time required when inverting the top head corner radius during installation, and an inability to withstand reverse pressure.

The flange of the Type F diaphragm is designed to seal like a gasket between the two flat surfaces of the cylinder and bonnet. The outside edge and bolt holes can be cut into any configuration desired. An effective seal should be obtained by compressing the flange area 20 – 30% by thickness. To extend cycle life and reduce “four cornering” of the diaphragm, a double taper design may be utilized (see Figure 1). This design reduces the diameter of the bottom end of the diaphragm which minimizes excess material in this area and relieves circumferential compressive stress.

Dimensions and Tolerances:

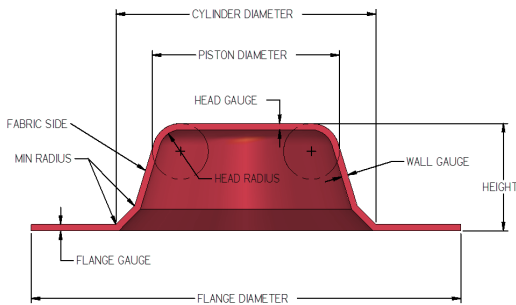

Double Taper Diaphragm - Figure 1

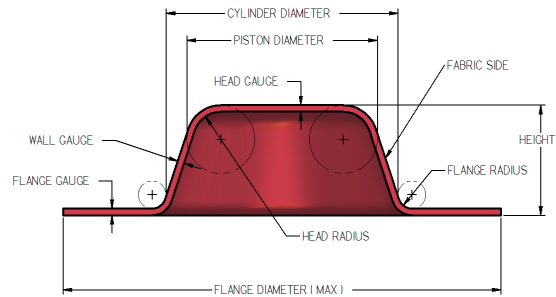

Top Hat Diaphragm - Figure 2

Cylinder Diameter	.25 to .99	6 to 25	1.00 to 2.50	25 to 64	2.51 to 4.00	64 to 102	4.01 to 8.00	102 to 205	8.01 & Up	205 & Up
Height	See available sizes table.									
Cylinder Diameter	Tolerances on Cylinder Diameter and Piston Diameter are $\pm .010$ " per inch of diameter, but the tolerance will be no less than $\pm .060$ ".									
Piston Diameter										
Head Thickness & Flange Thickness	.015 \pm .003	.038 \pm .008	.017 \pm .004	.043 \pm .010	.024 \pm .004	.061 \pm .010	.035 \pm .005	.089 \pm .013	.045 \pm .007	1.14 \pm .018
Wall Gauge	.015 \pm .003	.038 \pm .008	.017 \pm .004	.043 \pm .010	.024 \pm .004	.061 \pm .010	.035 \pm .005	.089 \pm .013	.045 \pm .007	1.14 \pm .018
Piston Radius	.094	2.39	.125	3.18	.156	3.96	.250	6.35	.250	6.35
Flange Radius	.031	0.79	.063	1.60	.094	2.39	.125	3.18	.125	3.18
Flange Diameter	Cyl. Diam. +.750	Cyl. Diam. +19.05	Cyl. Diam. +1"	Cyl. Diam. + 25.40	Cyl. Diam. +1.50	Cyl. Diam. +38.10	Cyl. Diam. +2"	Cyl. Diam. +50.80	Cyl. Diam. +2"	Cyl. Diam. +50.80

Diaphragm Flange Diameter and Hole Trim Tolerances:					
Diameter		Size	Position		
0 - 1.00"	.0 - 25.40	$\pm .010$ "	0.25	.010	0.25
1.01 - 3.00"	25.65 - 76.20	$\pm .020$ "	0.51	.020	0.51
Over 3.01"	Over 76.45	$\pm .030$ "	0.76	.030	0.76

Hole Spacing for Type F and FC Diaphragms

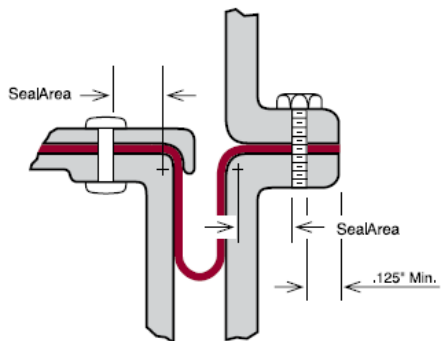

Maximum Working Pressure (psi)/kpa	(0-50)	0-350	(51-150)	357-1050	(151-300)	1057-2100	(301-500)	2107-3500
Seal Area Minimum (Inches)	.100	2.54	.150	3.81	.200	5.08	.250	6.35

Hole Spacing:

Perforations through the head or the flange should be located so that there is at least .100 inches minimum between the edges of holes. Also, holes should be located so that there is at least .125 inches between the edge of a hole and the trim periphery. It is also important to arrange the hole pattern so that the radial distance from the edge of the hole to the start of the blend radius at either the piston head or cylinder clamp flange is at least as far as indicated in the chart above.

Available Sizes

Type F Diaphragms

DiaCom Part #			Cylinder Diameter		Piston Diameter		Height		Gauge (Approximate)		Convolution Width		* Effective Pressure Area		Maximum Half-Stroke	
F	34	39	0.34	9	0.22	6	0.39	10	0.15	0.38	0.60	15	0.06	0.4	0.17	4.3
F	37	31	0.37	9	0.25	6	0.31	8	0.15	0.38	0.60	15	0.08	0.5	0.09	2.3
F	44	44	0.44	11	0.31	8	0.44	11	0.15	0.38	0.65	17	0.11	0.7	0.21	5.3
F	62	50	0.62	16	0.50	13	0.50	13	0.50	0.38	0.60	15	0.25	1.6	0.28	7.1
F	62	65	0.62	16	0.47	12	0.65	17	0.24	0.61	0.75	19	0.23	1.5	0.47	11.9
F	75	38	0.75	19	0.62	16	0.38	10	0.10	0.25	0.65	17	0.37	2.4	0.12	3.0
F	75	62	0.75	19	0.62	16	0.62	16	0.11	0.28	0.65	17	0.37	2.4	0.36	9.1
F	75	62	0.75	19	0.62	16	0.62	16	0.15	0.38	0.65	17	0.52	3.4	0.36	9.1
F	89	58	0.89	23	0.71	18	0.58	15	0.15	0.38	0.90	23	0.50	3.3	0.21	5.3
F	100	44	1.00	25	0.81	21	0.44	11	0.10	0.25	0.95	24	0.64	4.1	0.06	1.5
F	100	62	1.00	25	0.81	21	0.62	16	0.17	0.43	0.95	24	0.64	4.1	0.24	6.1
F	100	100	1.00	25	0.81	21	1.00	25	0.17	0.43	0.95	24	0.64	4.1	0.62	15.7
F	112	44	1.12	28	0.94	24	0.44	11	0.17	0.43	0.90	23	0.83	5.4	0.07	1.8
F	112	69	1.12	28	0.94	24	0.69	18	0.17	0.43	0.90	23	0.83	5.4	0.32	8.1
F	118	53	1.18	30	0.97	25	0.53	13	0.17	0.43	1.05	27	1.30	8.3	0.22	5.6
F	137	112	1.37	35	1.19	30	1.12	28	0.17	0.43	0.90	23	1.29	8.3	0.75	19.1
F	150	62	1.50	38	1.31	33	0.62	16	0.17	0.43	0.95	24	1.55	10.0	0.24	6.1
F	150	75	1.50	38	1.31	33	0.75	19	0.17	0.43	0.95	24	1.55	10.0	0.37	9.4
F	150	94	1.50	38	1.31	33	0.94	24	0.20	0.51	0.95	24	1.55	10.0	0.56	14.2
F	156	141	1.56	40	1.38	35	1.41	36	0.17	0.43	0.60	15	1.63	10.5	1.04	26.4
F	162	44	1.62	41	1.44	37	0.44	11	0.17	0.43	0.90	23	1.84	11.9	0.07	1.8
F	162	46	1.62	41	1.47	37	0.46	12	0.20	0.51	0.75	19	2.26	12.1	0.07	1.8
F	162	69	1.62	41	1.44	37	0.69	18	0.17	0.43	0.90	23	1.84	11.9	0.32	8.1
F	175	106	1.75	44	1.56	40	1.06	27	0.17	0.43	0.95	24	2.15	13.9	0.68	17.3
F	175	175	1.75	44	1.56	40	1.75	44	0.15	0.38	0.95	24	2.15	13.9	1.37	34.8
F	200	75	2.00	51	1.81	46	0.75	19	0.17	0.43	0.95	24	2.85	18.4	0.37	9.4
F	200	100	2.00	51	1.81	46	1.00	25	0.16	0.41	0.95	24	2.85	18.4	0.62	15.7
F	200	162	2.00	51	1.81	46	1.62	41	0.17	0.43	0.95	24	2.85	18.4	1.24	31.5
F	200	200	2.00	51	1.81	46	2.00	51	0.17	0.43	0.95	24	2.85	18.4	1.62	41.1
F	212	131	2.12	54	1.94	49	1.31	33	0.17	0.43	0.90	23	3.23	20.9	0.94	23.9
F	225	62	2.25	57	2.06	52	0.62	16	0.20	0.43	0.95	24	3.65	23.5	0.26	6.6
F	225	94	2.25	57	2.06	52	0.94	24	0.17	0.43	0.95	24	3.65	23.5	0.56	14.2
F	225	137	2.25	57	2.06	52	1.37	35	0.17	0.43	0.95	24	3.65	23.5	0.99	25.1
F	250	142	2.50	64	2.31	59	1.42	36	0.17	0.43	0.95	24	4.54	29.3	1.04	26.4
F	250	150	2.50	64	2.31	59	1.50	38	0.17	0.43	0.95	24	4.54	29.3	1.12	28.4
F	250	153	2.50	64	2.00	51	1.53	39	0.18	0.46	2.50	6.4	3.97	25.6	1.10	27.9
F	275	112	2.75	70	2.44	62	1.12	28	0.24	0.61	1.55	3.9	6.62	34.1	0.57	14.5
F	300	119	3.00	76	2.69	68	1.19	30	0.24	0.61	1.55	3.9	6.35	41.0	0.64	16.3
F	300	300	3.00	76	2.69	68	3.00	76	0.24	0.61	1.55	3.9	6.35	41.0	2.42	61.5
F	319	100	3.19	81	2.88	73	1.00	25	0.24	0.61	1.55	3.9	8.78	46.7	0.45	11.4
F	325	131	3.25	83	2.94	75	1.31	33	0.24	0.61	1.55	3.9	7.52	48.5	0.76	19.3
F	328	148	3.28	83	2.75	70	1.48	38	0.17	0.43	2.65	6.7	7.14	46.0	0.76	19.3
F	350	212	3.50	89	3.18	81	2.12	54	0.30	0.76	1.60	4.1	87.6	56.5	1.72	43.7
F	375	132	3.75	95	3.44	87	1.32	34	0.22	0.56	1.55	3.9	10.15	65.5	0.77	19.6
F	400	400	4.00	102	3.69	94	4.00	102	0.24	0.61	1.55	3.9	11.61	74.9	3.45	87.6
F	402	154	4.02	102	3.70	94	1.54	39	0.32	0.81	1.60	4.1	11.70	75.5	0.88	22.4
F	450	275	4.50	114	4.00	102	2.75	70	0.35	0.89	2.50	6.4	14.18	91.5	1.97	50.0
F	460	450	4.60	117	4.00	102	4.50	114	0.40	1.02	3.00	7.6	14.51	93.6	3.60	91.4
F	475	82	4.75	121	4.37	111	0.82	21	0.35	0.89	1.90	4.8	16.32	105.3	0.10	2.5
F	475	187	4.75	121	4.27	108	1.87	47	0.35	0.89	2.40	6.1	15.97	103.0	1.09	27.7
F	500	300	5.00	127	4.50	114	3.00	76	0.35	0.89	2.50	6.4	17.71	114.3	2.22	56.4
F	550	175	5.50	140	5.00	127	1.75	44	0.35	0.89	2.50	6.3	21.64	139.6	0.97	24.6
F	550	337	5.50	140	5.00	127	3.37	86	0.35	0.89	2.50	6.3	21.64	139.6	2.59	65.8
F	600	513	6.00	152	5.50	140	5.13	130	0.40	1.02	2.50	6.3	25.96	167.4	4.35	110.5
F	675	232	6.75	171	6.25	159	2.32	59	0.35	0.89	2.50	6.3	33.17	214.0	1.54	39.1
F	700	414	7.00	178	6.50	165	0.89	414	0.40	1.02	2.50	6.4	35.77	90.89	3.01	76.5
F	750	150	7.50	191	7.00	178	1.50	38	0.35	0.89	2.50	6.4	41.26	266.2	0.72	18.3
F	800	400	8.00	203	7.50	191	4.00	102	0.35	0.89	2.50	6.3	47.15	304.2	3.22	81.8
F	1000	200	10.0	254	9.25	235	2.00	51	0.50	1.27	3.75	9.5	72.72	469.2	1.02	25.9
F	1000	225	10.0	254	9.50	241	2.25	57	0.35	0.89	2.50	6.4	74.62	481.4	1.47	37.3
F	1000	412	10.0	254	9.50	241	4.12	105	0.40	1.02	2.50	6.4	82.47	532.1	3.34	84.8
F	1188	538	11.88	302	11.38	289	5.38	137	0.40	1.02	2.50	6.3	106.18	685	4.60	116.8

(Standard part design dimensions are for reference only. There may be differences between note and actual part dimensions. Please contact DiaCom before designing hardware intended for standard parts.)

Type FC Diaphragms

General Description:

In this style, the piston and the flange are molded on the same plane. The benefit of this style is that the handwork of forming the convolution is eliminated, which greatly reduces the assembly time. This would be of importance in high volume applications. The drawbacks to this type of diaphragm are: a built-in spring rate, due to the molded-in convolution, which must be considered during the design stage, and a limited stroke-

to-bore ratio. To improve this ratio, an offset preconvoluted diaphragm can be designed (see FC Offset figure at bottom of page). In this shape, the piston head and flange are molded offset to each other, thereby putting all the additional stroke capabilities on one side of the convolution. This provides a longer stroking diaphragm which still maintains the assembly ease of a preconvoluted diaphragm.

Dimensions and Tolerances:

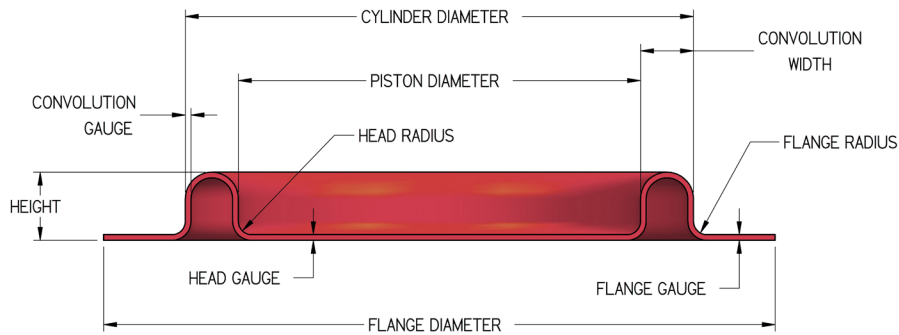

Cylinder Diameter	.25 to .99	6 to 25	1.00 to 2.50	25 to 64	2.51 to 4.00	64 to 102	4.01 to 8.00	102 to 205	8.01 & Up	205 & Up
Height	See available sizes table.									
Cylinder Diameter	Tolerances on Cylinder Diameter and Piston Diameter are $\pm .010$ " per inch of diameter, but the tolerance will be no less than $\pm .060$ ".									
Piston Diameter										
Head Thickness & Flange Thickness	.015 \pm .003	.038 \pm .008	.017 \pm .004	.043 \pm .010	.024 \pm .004	.061 \pm .010	.035 \pm .005	.089 \pm .013	.045 \pm .007	1.14 \pm .018
Wall Gauge	.015 \pm .003	.038 \pm .008	.017 \pm .004	.043 \pm .010	.024 \pm .004	.061 \pm .010	.035 \pm .005	.089 \pm .013	.045 \pm .007	1.14 \pm .018
Piston & Flange Radius	.031	0.79	.063	1.60	.094	2.39	.125	3.18	.125	3.18
Flange Diameter	Cyl. Diam. +.750	Cyl. Diam. +19.05	Cyl. Diam. +1"	Cyl. Diam. + 25.40	Cyl. Diam. +1.50	Cyl. Diam. +38.10	Cyl. Diam. +2"	Cyl. Diam. +50.80	Cyl. Diam. +2"	Cyl. Diam. +50.80

Note: Please See Page 14 (Type F Diaphragms) for Hole Spacing Information.

Diaphragm Flange Diameter and Hole Trim Tolerances:					
Diameter		Size	Position		
0 - 1.00"	.0 - 25.40	$\pm .010$ "	0.254	.010	0.254
1.01 - 3.00"	25.65 - 76.20	$\pm .020$ "	0.508	.020	0.508
Over 3.01"	Over 76.45	$\pm .030$ "	0.762	.030	0.762

Angular relationship of holes $\pm 1/2$ degree.

FC Offset

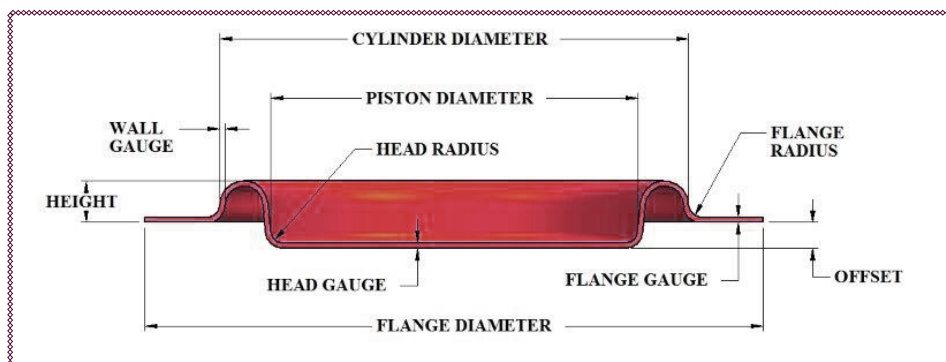

Available Sizes

Type FC Diaphragms

DiaCom Part #			Cylinder Diameter		Piston Diameter		Height	Gauge (Approximate)		Convolution Width		*Effective Pressure Area	Maximum Half-Stroke			
FC	38	12	0.38	10	.25	6	0.12	3	.013	0.33	.065	1.7	0.08	0.5	0.11	2.8
FC	50	10	0.50	13	0.31	8	0.10	3	.020	0.51	.095	2.4	0.13	0.8	0.01	0.3
FC	50	10	0.50	13	0.38	10	0.10	3	.015	0.38	.060	1.5	0.15	1.0	0.05	1.3
FC	51	08	0.50	13	0.31	8	0.08	2	.015	0.38	.095	2.4	0.13	0.8	0.01	0.3
FC	56	06	0.56	14	0.50	13	0.06	2	.016	0.41	.030	0.8	0.22	1.4	0.01	0.3
FC	62	07	0.62	16	0.44	11	0.07	2	.015	0.38	.090	2.3	0.22	1.4	0.04	1.0
FC	62	10	0.62	16	0.50	13	0.10	3	.015	0.38	.060	1.5	0.25	1.6	0.07	1.8
FC	71	15	0.71	18	0.53	13	0.16	4	.018	0.46	.090	2.3	0.30	1.9	0.10	2.5
FC	72	04	0.72	18	0.52	13	0.04	1	.015	0.38	.100	2.5	0.30	1.9	0.01	0.3
FC	72	09	0.72	18	0.52	13	0.09	2	.015	0.38	.100	2.5	0.30	1.9	0.06	1.5
FC	75	10	0.75	19	0.62	16	0.10	3	.015	.038	.065	1.7	0.37	2.4	0.07	1.8
FC	75	10	0.75	19	0.63	16	0.10	3	.015	.038	.060	1.5	0.37	2.4	0.07	1.8
FC	87	10	0.87	22	0.75	19	0.10	3	.015	.038	0.60	1.5	0.52	3.3	0.07	1.8
FC	88	10	0.88	22	0.66	17	0.10	3	.017	0.43	.110	2.8	0.47	3.0	0.01	0.3
FC	100	15	1.00	25	0.81	21	0.15	4	.017	0.43	.095	2.4	0.64	4.1	0.08	2.0
FC	100	15	1.00	25	0.81	21	0.15	4	.015	0.38	0.95	2.4	0.64	4.1	0.08	2.0
FC	102	06	1.02	26	0.80	20	0.06	2	.008	0.20	.110	2.8	0.65	4.2	0.01	0.3
FC	106	06	1.06	27	0.94	24	0.06	2	.012	0.30	0.60	1.5	0.79	5.1	0.01	0.3
FC	107	15	1.07	27	0.88	22	0.15	4	.013	0.33	.095	2.4	0.75	4.8	0.08	2.0
FC	116	15	1.16	29	0.98	25	0.15	4	.013	0.33	.090	2.3	0.90	5.8	0.08	2.0
FC	117	12	1.17	30	0.87	22	0.12	3	.020	0.51	.150	3.8	0.82	5.3	0.01	0.3
FC	125	09	1.25	32	1.03	26	0.09	2	.017	0.43	.110	2.8	1.02	6.6	0.01	0.3
FC	125	15	1.25	32	1.06	27	0.15	4	.017	0.43	.095	2.4	1.05	6.8	0.08	2.0
FC	132	10	1.32	34	1.08	27	0.10	3	.020	0.51	.120	3.0	1.13	7.3	0.01	0.3
FC	137	15	1.37	35	1.19	30	0.15	4	.020	0.51	.090	2.3	1.29	8.3	0.08	2.0
FC	138	18	1.38	35	1.06	27	0.18	5	.025	0.64	.160	4.1	1.17	7.5	0.01	0.3
FC	150	05	1.50	38	1.25	32	0.05	1	.010	0.25	.125	3.2	1.48	9.6	0.01	0.3
FC	150	12	1.50	38	.094	24	0.13	3	.022	0.56	.280	7.1	1.17	7.5	0.01	0.3
FC	150	15	1.50	38	1.31	33	0.15	4	.017	0.43	.095	2.4	1.55	10.0	0.08	2.0
FC	155	15	1.55	39	1.30	33	0.15	4	.020	0.51	.125	3.2	1.59	10.3	0.01	0.3
FC	160	09	1.60	41	1.33	34	0.09	2	.013	0.33	.135	3.4	1.68	10.9	0.01	0.3
FC	160	09	1.61	41	1.33	34	0.09	2	.020	0.51	.140	3.6	1.70	10.9	0.01	0.3
FC	162	15	1.62	41	1.44	37	0.15	4	.017	0.43	.090	2.3	1.84	11.9	0.08	2.0
FC	163	09	1.63	41	1.44	37	0.09	2	.015	0.38	.095	2.4	1.85	11.9	0.01	0.3
FC	170	28	1.70	43	1.27	32	0.28	7	.030	0.76	.215	5.5	1.73	11.2	0.10	2.5
FC	173	09	1.73	44	1.50	38	0.09	2	.013	0.33	.115	2.9	2.05	13.2	0.01	0.3
FC	173	09	1.73	44	1.5	38	0.09	2	.020	0.51	.115	2.9	2.05	13.2	0.01	0.3
FC	175	15	1.75	44	1.56	40	0.15	4	.013	.33	.095	2.4	2.15	13.9	0.06	2.0
FC	199	12	1.99	51	1.54	39	0.12	3	.020	0.51	.225	5.7	2.45	15.8	0.01	0.3
FC	200	15	2.00	51	1.81	46	0.15	4	.017	0.43	.095	2.4	2.85	18.4	0.08	2.0
FC	212	12	2.12	54	1.88	48	0.12	3	.018	0.46	.120	3.0	3.14	20.3	0.04	1.0
FC	225	15	2.25	57	2.06	52	0.15	4	.017	0.43	.095	2.4	3.65	23.5	0.08	2.0
FC	250	15	2.50	64	2.31	59	0.15	4	.017	0.43	.095	2.4	4.54	29.3	0.08	2.0
FC	295	12	2.95	75	2.70	69	0.12	3	.017	0.43	.125	3.2	6.26	40.4	0.01	0.3
FC	300	25	3.00	76	2.69	68	0.25	6	.024	0.61	.155	3.9	6.35	41.0	0.15	3.8
FC	308	12	3.08	78	2.70	69	0.12	3	.017	.043	.190	4.8	6.56	42.3	0.01	0.3
FC	325	12	3.25	83	3.00	76	0.12	3	.017	0.43	.125	3.2	7.67	49.5	0.01	0.3
FC	402	27	4.02	102	3.66	93	0.27	7	.035	0.89	.180	4.6	11.58	74.7	0.11	2.8
FC	425	37	4.25	108	3.75	95	0.37	9	.035	0.89	.250	6.4	12.56	81.0	0.24	6.1
FC	600	37	6.00	152	5.50	140	0.37	9	.035	0.89	.250	6.4	25.95	167.4	0.24	6.1
FC	1150	50	11.50	292	11.00	279	0.50	13	.045	1.14	.250	6.4	99.35	641.0	0.37	9.4

(Standard part design dimensions are for reference only. There may be differences between note and actual part dimensions. Please contact DiaCom before designing hardware intended for standard parts.)

Type D Diaphragms

General Description:

This style diaphragm is the same as the Type F in all respects except flange mounting. The parts are molded with what equates to half of an O-ring on the flange rather than a large flat surface. This O-Ring half fits into a groove machined into the cylinder half of the hardware. Sealing is achieved by squeezing

the bead into a properly-sized groove (see table at bottom of page). The cylinder and bonnet can then be designed to make positive contact when assembled, eliminating the need for a closely controlled assembly torque. It also reduces the overall diameter of the diaphragm, reducing the hardware diameter.

Dimensions and Tolerances:

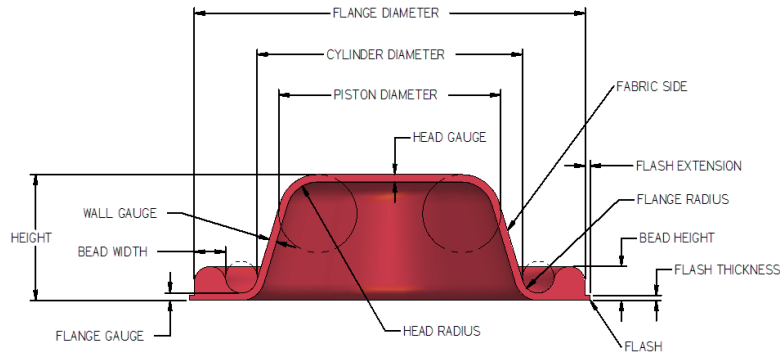

Cylinder Diameter	.37 to .99	9 to 25	100 to 2.50	25 to 64	2.51 to 4.0	64 to 102	4.01 to 8.00	102 to 205	8.01 & Up	205 & Up
Height	See available sizes table.									
Cylinder Diameter	Tolerances on Cylinder Diameter and Piston Diameter are $\pm .010$ " per inch of diameter but the tolerance will be no less than $\pm .010$ " or greater than $\pm .060$ ".									
Piston Diameter										
Head Thickness & Flange Thickness	.015 \pm .003	.038 \pm .008	.017 \pm .004	.043 \pm .010	.024 \pm .004	.061 \pm .010	.035 \pm .005	.089 \pm .013	.045 \pm .007	.114 \pm .018
Wall Gauge	.015 \pm .003	.038 \pm .008	.017 \pm .004	.043 \pm .010	.024 \pm .004	.061 \pm .010	.035 \pm .005	.089 \pm .013	.045 \pm .007	.114 \pm .018
Flash Projection	.025 Max	0.64 Max	.025 Max	0.64 Max	.035 Max	0.89 Max	.040 Max	1.02 Max	.056 Max	1.42 Max
Flash Thickness	.025 Max	0.64 Max	.025 Max	0.64 Max	.035 Max	0.89 Max	.040 Max	1.02 Max	.056 Max	1.42 Max
Piston Radius	.094	2.39	.125	3.18	.156	3.96	.250	6.35	.250	6.35
Flange Radius	.031	0.79	.063	1.60	.094	2.39	.125	3.18	.125	3.18
Flange Diameter	Cyl. Diam \pm .313	Cyl. Diam \pm .795	Cyl. Diam \pm .500	Cyl. Diam \pm 12.70	Cyl. Diam \pm .750	Cyl. Diam \pm 19.05	Cyl. Diam. +1"	Cyl. Diam \pm .2540	Cyl. Diam. +1"	Cyl. Diam \pm 25.40
Bead Width	.094 \pm .003	2.39 \pm .008	.125 \pm .003	3.18 \pm .008	.187 \pm .003	4.75 \pm .008	.250 \pm .003	6.35 \pm .008	250 \pm .004	6.35 \pm .010
Bead Height	.094 \pm .004	2.41 \pm .010	.135 \pm .004	3.43 \pm .010	.200 \pm .005	5.08 \pm .013	.270 \pm .007	6.86 \pm .018	270 \pm .008	6.86 \pm .020

Diaphragm Flange Diameter and Hole Trim Tolerances:					
Diameter		Size		Position	
0. - 1.00"	0 - 25.40	$\pm .010$ "	0.25	.010	0.25
1.01 - 3.00"	25.65 - 76.20	$\pm .020$ "	0.51	.020	0.51
Over 3.01"	Over 76.45	$\pm .030$ "	0.76	.030	0.76

Angular relationship of holes \pm 1/2 degree.

Hardware Recommendations:

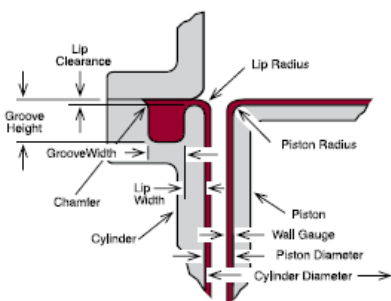

Cylinder Diameter	.25 - .99	6 - 25	100 - 2.50	25 - 64	2.51 - 4.00	64 - 102	4.01 - 8.00	102 - 205	8.01 & Up	205 & Up
Groove Width \pm .003 .008 \pm	.109	2.77	.141	3.58	.219	5.56	.281	7.14	.281	7.14
Groove Height \pm .002 .005 \pm	.076	1.93	.108	2.74	.160	4.06	.216	5.49	.216	5.49
Lip & Piston Corner Radii	.031	0.79	.063	1.60	.094	2.39	.125	3.18	.125	3.18
Lip Width \pm .004 .008 \pm	.062	1.57	.125	3.18	.187	4.75	.250	6.35	.250	6.35
Lip Clearance \pm .004 .008 \pm	.021	0.53	.021	0.53	.031	0.79	.036	0.91	.048	1.22

Available Sizes

Type D Diaphragms

DiaCom Part #		Cylinder Diameter	Piston Diameter		Height		Gauge (Approximate)		Convolution Width	* Effective Pressure Area	Maximum Half-Stroke					
D	50	38	0.50	13	0.37	9	0.38	10	.015	0.38	.065	1.7	0.15	1.0	0.15	3.8
D	62	51	0.62	16	0.47	12	0.51	13	.015	0.38	.075	1.9	0.23	1.5	0.25	6.4
D	62	50	0.62	16	0.50	13	.050	13	.015	0.38	.060	1.5	0.25	1.6	0.28	7.1
D	62	68	0.62	16	0.50	13	0.68	13	0.15	0.38	.060	1.5	0.25	1.6	0.41	10.4
D	79	79	0.79	20	0.59	15	0.80	20	0.17	0.43	.100	2.5	0.37	2.4	0.66	16.8
D	81	69	0.81	21	0.69	18	0.69	18	0.16	0.41	.060	1.5	0.44	2.8	0.47	11.9
D	87	31	0.87	22	0.75	19	0.31	8	.015	0.38	.060	1.5	0.52	3.3	0.09	2.3
D	94	81	0.94	24	0.81	21	0.81	21	0.17	0.43	.065	1.7	0.60	3.4	0.58	14.7
D	100	48	1.00	25	0.81	21	0.48	12	.012	0.30	0.95	2.4	0.64	4.1	0.10	2.5
D	100	81	1.00	25	0.81	21	0.81	21	.020	0.51	.095	2.4	0.64	4.1	0.43	10.9
D	100	100	1.00	25	0.81	21	1.00	25	.017	.043	0.95	2.4	0.64	4.1	0.62	15.7
D	112	94	1.12	28	0.94	24	0.94	24	0.17	0.43	.090	2.3	.083	5.4	0.57	14.5
D	118	71	1.18	30	0.98	25	0.71	18	0.21	0.43	.100	2.5	0.92	5.9	0.31	7.6
D	128	74	1.28	33	1.08	27	0.74	19	0.17	0.43	.100	2.5	1.09	7.0	0.34	8.6
D	137	44	1.37	35	1.19	30	0.44	11	.017	0.43	.090	2.3	1.29	8.3	0.07	1.8
D	137	56	1.37	35	1.19	30	0.56	14	.017	0.43	.090	2.3	1.29	8.3	0.18	4.6
D	137	137	1.37	35	1.19	30	1.37	35	.017	0.43	.090	2.3	1.29	8.3	1.00	25.4
D	138	110	1.38	35	1.18	30	1.10	28	.017	0.43	.100	2.5	1.29	8.3	0.97	24.6
D	150	44	1.50	38	1.31	33	0.44	11	.017	0.43	.095	2.4	1.55	10.0	0.05	1.5
D	150	125	1.50	38	1.31	33	1.25	32	.017	0.43	.095	2.4	1.55	10.0	0.87	22.1
D	160	135	1.60	41	1.40	36	1.35	34	.015	0.38	.100	2.5	1.77	11.4	1.22	31.0
D	162	69	1.62	41	1.25	32	0.69	18	.014	0.36	.185	4.7	1.62	10.4	0.16	4.1
D	167	66	1.67	42	1.42	36	0.66	17	0.17	0.43	.125	3.2	1.87	12.1	0.22	5.6
D	175	52	1.75	44	1.56	40	0.52	13	.017	0.43	.095	2.4	2.15	13.9	0.14	3.6
D	175	75	1.75	44	1.56	40	0.75	19	.017	0.43	.095	2.4	2.15	13.9	0.37	9.4
D	200	81	2.00	51	1.81	46	0.81	21	.020	0.51	.095	2.4	2.85	18.4	0.43	10.9
D	200	125	2.00	51	1.81	46	1.25	32	.017	0.43	.095	2.4	2.85	18.4	0.87	22.1
D	200	200	2.00	51	1.81	46	2.00	51	.017	0.43	.095	2.4	2.85	18.4	1.62	41.1
D	225	81	2.25	57	2.06	52	1.81	46	.017	0.43	.095	2.4	3.65	23.5	1.42	36.1
D	225	94	2.25	57	2.06	52	0.94	24	.017	0.43	.095	2.4	3.65	23.5	0.56	14.2
D	225	137	2.25	57	2.06	52	1.37	35	.017	0.43	.095	2.4	3.65	23.5	0.99	25.1
D	225	211	2.25	57	2.06	52	2.11	54	.017	0.43	.095	2.4	3.65	23.5	1.73	43.9
D	250	106	2.50	64	2.31	59	1.06	27	.017	0.43	.095	2.4	4.54	29.3	0.68	17.3
D	250	150	2.50	64	2.31	59	1.50	38	.017	0.43	.095	2.4	4.54	29.3	1.12	28.4
D	250	212	2.50	64	2.31	59	2.12	54	.017	0.43	.095	2.4	4.54	29.3	1.74	44.2
D	260	84	2.60	66	2.40	61	0.84	21	.017	0.43	.100	2.5	4.91	31.7	0.71	18.0
D	300	175	3.00	76	2.69	68	1.75	44	.024	0.61	.155	3.9	6.35	41.0	1.20	30.5
D	300	300	3.00	76	2.69	68	3.00	76	.024	0.61	.155	3.9	6.35	41.0	2.45	62.2
D	325	194	3.25	83	2.94	75	1.94	49	.024	0.61	.155	3.9	7.52	48.5	1.39	35.3
D	375	225	3.75	95	3.44	87	2.25	57	.024	0.61	.155	3.9	10.15	65.5	1.70	43.2
D	375	375	3.75	95	3.44	87	3.75	95	.024	0.61	.155	3.9	10.15	65.5	3.20	81.3
D	386	400	3.86	98	3.54	90	4.00	102	.030	0.76	.160	4.1	10.75	69.3	3.80	96.5
D	400	100	4.00	102	3.69	94	1.00	25	.024	0.61	.155	3.9	11.61	74.9	0.45	11.4
D	550	175	5.50	140	5.00	127	1.75	44	.035	0.89	.250	6.4	21.64	139.6	.97	24.6
D	800	187	8.00	203	7.50	191	1.87	47	.035	0.89	.250	6.4	47.15	304.2	1.09	27.7
D	800	450	8.00	203	7.50	191	4.50	114	.035	0.89	.250	6.4	47.15	304.2	3.72	94.5
D	1200	100	12.00	305	11.50	292	1.00	25	0.45	1.14	.250	6.4	108.38	699.2	0.22	5.6
D	1350	100	13.50	343	13.0	330	1.00	25	.045	1.14	.250	6.4	137.82	889.1	0.22	5.6
D	1500	100	15.0	381	14.50	368	1.00	25	.045	1.14	.250	6.4	170.79	1101.8	0.22	5.6
D	1500	100	15.0	381	14.50	368	1.00	25	.045	1.14	.250	6.4	170.79	1101.8	0.22	5.6

Type DC Diaphragms

General Description:

This style diaphragm is similar in function to the Type FC diaphragm, while the sealing and hardware designs are the same as the Type D.

Dimensions and Tolerances:

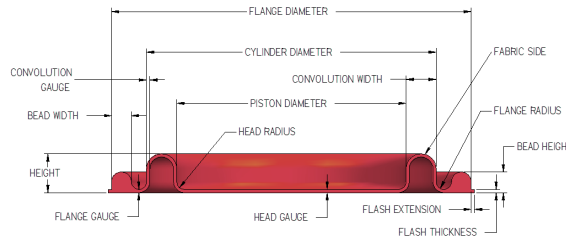

Cylinder Diameter	.37 to .99	9 to 25	1.00 to 2.50	25 to 64	2.51 to 4.00	64 to 102	4.01 to 8.00	102 to 205	8.01 & Up	205 & Up
Height	(See available sizes table.)									
Cylinder Diameter	Tolerances on Cylinder Diameter and Piston Diameter are $\pm .010"$ per inch of diameter, but the tolerance will be no less than $\pm .010"$ or greater than $\pm .060"$									
Piston Diameter										
Head & Flange Thickness	.015 \pm .003	0.38 \pm 0.08	.017 \pm .004	0.43 \pm 0.10	.024 \pm .004	.061 \pm 0.10	.031 \pm .005	.089 \pm 0.13	.045 \pm .007	1.14 \pm 0.18
Wall Gauge	.015 \pm .003	0.38 \pm 0.08	.017 \pm .004	0.43 \pm 0.10	.024 \pm .004	.061 \pm 0.10	.031 \pm .005	.089 \pm 0.13	.045 \pm .007	1.14 \pm 0.18
Flash Projection	.025 Max	0.64 Max	.025 Max	0.64 Max	.035 Max	.089 Max	.40 Max	102 Max	.56 Max	1.42 Max
Flash Thickness	.025 Max	0.64 Max	.025 Max	0.64 Max	.035 Max	.089 Max	.40 Max	102 Max	.56 Max	1.42 Max
Piston/Flange Radius	.031	.79	.063	1.60	.094	2.39	.125	3.18	.125	3.18
Flange Diameter	Cyl. Diam. + .313	Cyl. Diam. + .795	Cyl. Diam. + .500	Cyl. Diam. + 12.70	Cyl. Diam. + .750	Cyl. Diam. + 19.05	Cyl. Diam. + 1"	Cyl. Diam. + 25.40	Cyl. Diam. + 1"	Cyl. Diam. + 25.40
Bead Width	.094 \pm .003	2.39 \pm 0.08	.125 \pm .003	3.18 \pm 0.08	.187 \pm .003	4.75 \pm 0.08	.250 \pm .003	6.35 \pm 0.08	.250 \pm .004	6.35 \pm 0.10
Bead Height	.095 \pm .004	2.41 \pm 0.10	.135 \pm .004	3.43 \pm 0.10	.200 \pm .005	5.08 \pm 0.13	.270 \pm .006	6.86 \pm 0.15	.270 \pm .008	6.86 \pm 0.20

Diameter	Size	Position
0 - 1.00"	0 - 25.40	$\pm .010"$ 0.25 .010 0.25
1.01 - 3.00"	25.65 - 76.20	$\pm .020"$ 0.51 .020 0.51
Over 3.01"	Over 76.45	$\pm .030"$ 0.76 .020 0.76

Angular relationship of holes: $\pm 1/2$ degree.

Hardware Recommendations:

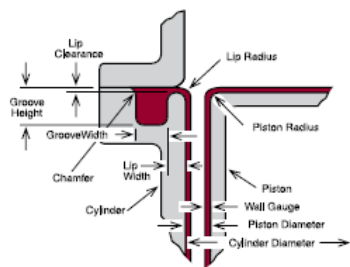

Cylinder Diameter	.25 - .99	6 - 25	1.00 - 2.50	25 - 64	2.51 - 4.00	64 - 102	4.01 - 8.00	102 - 205	8.01 & Up	205 & Up
Groove Width $\pm .003$ 0.08 \pm	.109	2.77	.141	3.58	.219	5.56	.281	7.14	.281	7.14
Groove Height $\pm .002$ 0.05 \pm	.076	1.93	.108	2.74	1.60	4.06	.216	5.49	.216	5.49
Lip & Piston Corner Radii	.031	.079	.063	1.60	.094	2.39	.125	3.18	.125	3.18
Lip Width $\pm .003$ 0.08 \pm	.062	1.57	1.25	3.18	.187	4.75	.250	6.35	.250	6.35
Lip Clearance $\pm .003$ 0.08 \pm	.021	0.53	.021	0.53	.031	0.79	.036	0.91	.048	1.22

Available Sizes:

DiaCom Part #	Cylinder Diameter	Piston Diameter	Height	Gauge (Approximate)	Convolution Width	*Effective Pressure Area	Maximum Half-Stroke
DC 37 12	0.37	9	0.27	7	0.12	3	.017 0.43 .050 1.3 0.08 0.5 0.09 2.3
DC 62 10	0.62	16	0.50	13	0.10	3	.020 0.51 .060 1.5 0.25 1.6 0.07 1.8
DC 91 15	0.91	23	0.72	18	0.15	4	.020 0.51 .095 2.4 0.52 3.4 0.10 2.5
DC 125 15	1.25	32	1.05	27	0.15	4	.017 0.43 .100 2.5 1.04 6.7 0.04 1.0
DC 150 15	1.50	38	1.31	33	0.15	4	.017 0.43 .095 2.4 1.55 10.0 0.05 1.3
DC 175 15	1.75	44	1.56	40	0.15	4	.017 0.43 .095 2.4 2.15 13.9 0.05 1.3

(Standard part design dimensions are for reference only. There may be differences between note and actual part dimensions. Please contact DiaCom before designing hardware intended for standard parts.)

Type O and OA Diaphragms

General Description:

Type O – This type of diaphragm has no flange. An O-ring is molded to the bottom of the sidewall. Unlike the other types of diaphragms, the Type O is put into convolution by folding the sidewall back onto itself. The bead is then squeezed into a groove machined into the bonnet half of the hardware. This type enables the greatest reduction in hardware diameter, while keeping a full stroke potential.

Type OA – This diaphragm type is a second generation to the Type O and fits into identical hardware. It differs from the Type O in that its sidewall attaches to the inside diameter of the O-ring and the fabric is on the outside, requiring the head corner radius to be inverted for installation. The Type OA tends to be easier to install, but basically the difference is personal preference.

Dimensions and Tolerances:

TYPE O

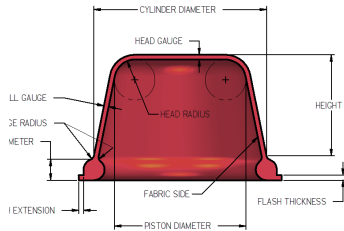

TYPE OA

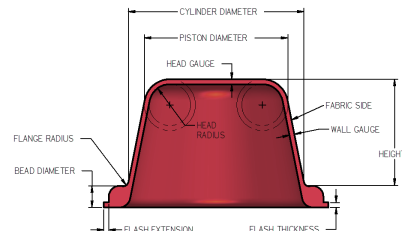

Cylinder Diameter	1.00 to 2.50	24 to 64	2.51 to 4.00	64 to 102	4.01 to 8.0	102 and up
Bead Diameter	.21	3.07	.151	3.84	242	6.15
Convolution Width	.094	2.39	.156	3.96	.025	6.15
Flash Projection	0.020 Max	0.51 Max	0.030 Max	0.76 Max	0.040 Max	1.02 Max
Flash Thickness	0.020 Max	.051 Max	0.030 Max	0.76 Max	0.040 Max	1.02 Max
Wall Gauge	.017	0.43	.024	0.61	.035	0.89
Piston Radius	.063	1.60	.094	2.39	.125	3.18
Piston Diameter	Cyl. Diameter less 1.88"	Cyl. Diameter less 4.78	Cyl. Diameter less 3.13"	Cyl. Diameter less 7.95	Cyl. Diameter less .500"	Cyl. Diameter less 12.70
Flange Radius	.032	0.81	.047	1.19	.063	1.60

Hardware Design:

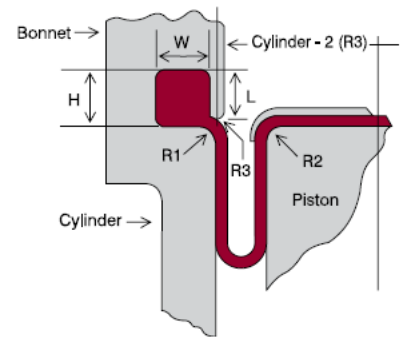

Cylinder Diameter	Bead Groove Width = W		Bead Groove Height = H		Flange & Piston Corner Radii = R1 & R2		Lip Radius = R3		Lip Height = L		
	1.00 - 2.50	25 to 64	.134	.318	.096	2.43	.063	1.60	.025	0.63	.100
2.51 - 4.00	64 - 102	.156	3.96	.122	3.10	.094	2.39	.032	0.81	.130	3.30
4.01 - 8.00	102 to 205	.263	6.35	.196	4.98	.125	3.18	.045	1.14	.204	5.18
8.01 & Up	205 & Up	.263	6.35	.196	4.98	.125	3.18	.045	1.14	.190	4.83

Available Sizes:

DiaCom Part #			Cylinder Diameter		Piston Diameter		Height		Gauge (Approximate)		Convolution Width	*Effective Pressure Area	Maximum Half-Stroke			
O	37	12	1.37	35	1.19	30	0.87	22	0.17	0.43	.090	2.3	1.29	8.3	0.52	13.2
O	150	62	1.50	38	1.31	33	0.62	16	.017	0.43	.095	2.4	1.55	10.0	0.29	7.4
O	150	94	1.50	38	1.31	33	0.94	24	.017	0.43	.095	2.4	1.55	10.0	0.61	15.5
O	175	144	1.75	44	1.56	40	1.44	37	.017	0.43	.095	2.4	2.15	13.9	1.13	28.7
O	180	144	1.80	46	1.38	35	1.44	37	.025	0.64	.210	5.3	1.98	12.8	0.80	20.3
O	187	150	1.87	47	1.69	43	1.50	38	.017	0.43	.090	2.3	2.49	16.0	1.15	29.2
O	200	162	2.00	51	1.81	46	1.62	41	.017	0.43	.095	2.4	2.85	18.4	1.27	32.3
O	200	200	2.00	51	1.87	47	2.00	51	0.17	0.43	.065	1.7	2.94	19.0	1.64	41.7
O	250	200	2.50	64	2.31	59	2.00	51	.017	0.43	.095	2.4	4.54	29.3	1.65	41.9
O	275	12	2.75	70	2.44	62	1.12	28	.024	0.61	.155	3.9	5.29	34.1	0.57	14.5
O	400	238	4.00	102	3.69	94	2.38	60	.035	0.89	1.55	3.9	11.61	74.9	1.83	46.5
O	500	312	5.00	127	4.50	114	3.12	79	.035	0.89	.250	6.4	17.71	114.3	2.28	57.9
O	600	440	6.00	152	5.50	140	4.40	112	.035	0.89	.250	6.4	25.95	167.40	3.56	90.4
OA	75	85	0.75	19	0.55	14	0.85	22	.017	0.43	.100	2.5	0.33	2.1	0.46	11.7
OA	106	145	1.06	27	0.94	24	1.45	37	.017	0.43	.060	1.5	0.79	5.1	1.12	28.4
OA	112	69	1.12	28	0.94	24	0.69	18	.017	0.43	.090	2.3	0.83	5.4	0.33	8.4
OA	137	53	1.37	35	1.19	30	0.53	13	.017	0.43	.090	2.3	1.29	8.3	0.17	4.3
OA	200	58	2.00	51	1.81	46	0.58	15	.017	0.43	.095	2.4	2.85	18.4	0.20	5.1
OA	283	160	2.83	72	2.52	64	1.60	41	.024	0.61	.155	3.9	5.62	36.2	1.09	27.7
OA	462	350	4.62	117	4.00	102	3.50	89	.035	0.89	.310	7.9	14.58	94.1	2.86	72.6
OA	475	225	4.75	121	4.25	108	2.25	57	.017	0.43	.250	6.4	15.90	102.6	1.22	31.0

(Standard part design dimensions are for reference only. There may be differences between note and actual part dimensions. Please contact DiaCom before designing hardware intended for standard parts.)

Type OB Diaphragms

General Description:

Type OB diaphragms have a rectangular bead molded inside their cylinder wall. This design requires the smallest hardware diameter of any diaphragm type. The Type OB diaphragm has only half the stroke capability of other diaphragm styles of the

same height. Because the clamping and sealing of this style diaphragm is against the inside wall of the cylinder, the stroke is restricted to the lower half of the diaphragm.

Hardware Design:

Stamped Retainer Plate Sealing Via Axial Compression

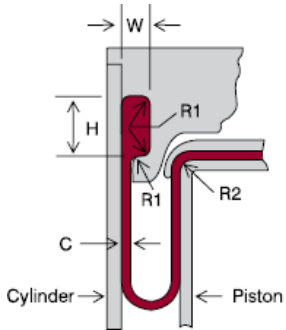

Cast Machined Retainer Plate Sealing Via Radial Compression

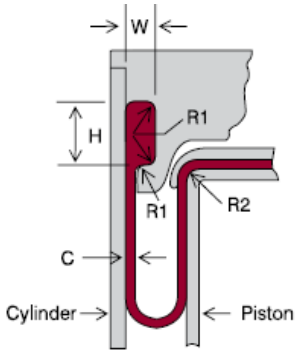

Dimensions and Tolerances:

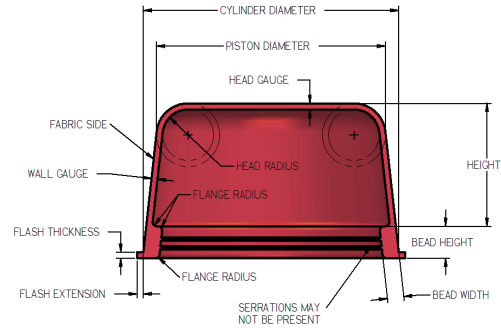

Cylinder Diameter	1.00 - 2.50	25 - 64	2.51 - 4.00	64 - 102	4.01 - 8.00	102 - 205	8.01 & Up	205 & Up
Height	See available sizes table.							
Cylinder Diameter	Tolerances on Cylinder Diameter and Piston Diameter are $\pm .010$ " per inch of diameter, but the tolerance will be no less than $\pm .010$ " or greater than ± 060 ".							
Piston Diameter								
Piston Radius	.63	1.60	.094	2.39	.125	3.18	.125	3.18
\pm Head Thickness	.017 \pm .004	0.43 \pm 0.10	.024 \pm .004	0.61 \pm 0.10	.035 \pm .005	0.89 \pm 0.13	.045 \pm .007	1.14 \pm 0.18
Wall Gauge	.017 \pm .004	0.43 \pm 0.10	.024 \pm .004	0.61 \pm 0.10	.035 \pm .005	0.89 \pm 0.13	.045 \pm .007	1.14 \pm 0.18
Flash Projection	.025 Max	0.64 Max	.035 Max	0.89 Max	.040 Max	1.02 Max	.056 Max	1.42 Max
Flash Thickness	.025 Max	0.64 Max	.035 Max	0.89 Max	.040 Max	1.02 Max	.056 Max	1.42 Max
Flange Radius	.031	0.79	.047	1.19	.063	1.60	.63	1.60
Bead Width	.080 \pm .003	2.03 \pm 0.08	.100 \pm .003	2.54 \pm .260	.120 \pm .003	3.05 \pm 0.08	.160 \pm .003	4.06 \pm 0.08
Bead Height	.150 \pm .005	3.81 \pm 0.13	.200 \pm .005	5.08 \pm 0.13	.260 \pm .005	6.60 \pm 0.13	.300 \pm .007	7.62 \pm 0.18

Cylinder Diameter	Bead Groove Width = W	Bead Groove Height = H	Lip Radius = R1	Piston Corner Radius = R2	Lip Clearance = C					
1.00 - 2.50	25 to 64	2.50	2.03	.150	3.81	.030	.063	.063	1.60	Sidewall Thickness $\pm .003$
2.51 - 4.00	64 to 102	.100	2.54	.200	5.08	.040	.094	.094	2.39	
4.01 - 8.00	102 - 205	1.20	3.05	.260	6.60	.050	.125	1.25	3.18	
8.01 & Up	205 & Up	1.60	4.06	.300	7.62	.060	1.88	1.88	4.78	

Available Sizes:

DiaCom Part #	Cylinder Diameter	Piston Diameter	Height	Gauge (Approximate)	Convolution Width	*Effective Pressure Area	Maximum Half-Stroke							
OB 250 178	250	64	213	54	178	45	.035	0.89	.185	4.7	4.21	271	1.39	35.3
OB 250 225	250	64	213	54	225	57	.035	0.89	.185	4.7	4.21	271	1.86	47.2
OB 250 258	250	64	213	52	258	66	.035	0.89	.220	5.6	4.08	26.3	2.14	54.4
OB 300 284	300	76	206	65	284	72	.035	0.89	.220	5.6	6.07	39.1	2.39	60.7
OB 300 284	300	76	256	67	284	72	.035	0.89	.185	4.7	6.22	40.1	2.45	62.2
OB 306 338	306	78	263	67	338	86	.035	0.89	.215	5.5	6.35	41.0	2.95	74.9
OB 362 340	362	92	263	79	340	86	.035	0.89	.250	6.4	8.92	57.5	2.33	59.2
OB 362 351	362	92	312	79	351	89	.035	0.89	.250	6.4	8.92	57.5	2.44	62.0
OB 363 406	362	92	312	79	406	103	.035	0.89	.250	6.4	8.92	57.5	3.09	78.5
OB 388 406	388	99	312	86	406	103	.035	0.89	.250	6.4	10.34	66.7	3.09	78.5
OB 388 413	388	99	333	85	413	105	.035	0.89	.275	7.0	10.20	65.8	3.12	79.2
OB 416 195	416	106	366	93	195	50	.035	0.89	.250	6.4	12.00	77.4	0.95	24.1
OB 416 353	416	106	366	93	353	90	.035	0.89	.250	6.4	12.00	77.4	2.53	64.3
OB 416 481	416	106	366	93	481	122	.035	0.89	.250	6.4	12.00	77.4	3.81	96.8
OB 475 374	475	121	425	108	374	95	.035	0.89	.250	6.4	15.90	102.6	2.61	66.3
OB 475 541	475	121	425	108	541	137	.035	0.89	.250	6.4	15.90	102.6	4.28	108.7

(Standard part design dimensions are for reference only. There may be differences between note and actual part dimensions. Please contact DiaCom before designing hardware intended for standard parts.)

Type P Diaphragms

General Description:

This diaphragm type, commonly referred to as dish-shaped, has a sidewall that slopes gradually from the cylinder to the piston. This diaphragm is designed to be flexed in both directions to its full height. It may be

double-coated to take pressure in both directions. Due to its wide convolution and gradual sidewall slope, the total travel and ability to withstand high pressures are limited. The effective pressure also varies through its stroke.

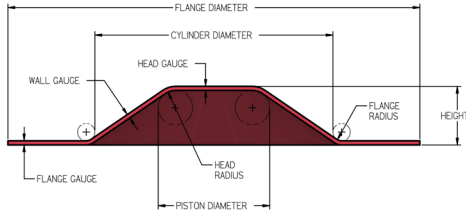

Dimensions and Tolerances:

Cylinder Diameter	1.00 - 2.50	25 - 64	2.51 - 4.00	64 - 102	4.01 - 8.00	102 - 205	8.01 & up	205 & Up
Height	See available sizes table.							
Cylinder Diameter	Tolerances on Cylinder Diameter and Piston Diameter are $\pm .010$ " per inch of diameter, but the tolerance will be no less than $\pm .010$ or greater than $\pm .060$ "							
Piston Diameter								
Piston Radius	.063	1.60	.094	2.39	.125	3.18	.125	3.18
Head & Flange Thickness	.017 \pm .005	0.43 \pm 0.13	.024 \pm .005	0.61 \pm 0.13	.035 \pm .005	0.89 \pm 0.13	.045 \pm .007	1.14 \pm 0.18
Wall Gauge	.017 \pm .005	0.43 \pm 0.13	.024 \pm .005	0.61 \pm 0.13	.035 \pm .005	0.89 \pm 0.13	.045 \pm .007	1.14 \pm 0.18
Flange Radius	.063	1.60	.094	2.39	.125	3.18	.125	3.18
Flange Diameter	Cyl. Diam +1"	Cyl. Diam +25.40	Cyl. Diam +1.50	Cyl. Diam +38.10	Cyl. Diam +2"	Cyl. Diam +50.80"	Cyl. Diam +2"	Cyl. Diam +50.80

Available Sizes:

DiaCom Part #	Cylinder Diameter	Piston Diameter	Height	Gauge (Approximate)	Convolution Width	*Effective Pressure Area	Maximum Half-Stroke							
P 106 16	1.06	.27	1.0	.25	0.16	4	.017	0.4	0.03	0.8	0.83	5.4	0.16	4.1
P 134 39	1.34	.34	.091	23	0.39	10	.017	0.4	0.22	5.5	0.99	6.4	0.39	9.9
P 144 40	1.44	.37	0.69	18	0.40	10	0.10	0.3	0.38	9.5	0.89	5.7	0.40	10.2
P 206 50	2.06	.52	1.06	27	0.50	13	0.60	1.5	0.50	12.7	1.91	12.3	0.50	12.7
P 250 50	2.50	.64	1.50	38	0.50	13	0.60	1.5	0.50	12.7	3.14	20.3	0.50	12.7
P 275 50	2.75	.70	1.75	44	0.50	13	0.60	1.5	0.50	12.7	3.97	25.6	0.50	12.7
P 275 53	2.75	.70	1.75	44	0.53	13	.025	0.6	0.50	12.7	3.97	25.6	0.53	13.5
P 288 37	2.88	.73	1.88	48	0.37	9	0.30	0.8	0.50	12.7	4.45	28.7	0.37	9.4
P 300 50	3.00	.76	2.00	51	0.50	13	0.60	1.5	0.50	12.7	4.91	31.7	0.50	12.7
P 325 52	3.25	.83	1.77	45	0.52	13	.025	0.6	0.74	18.8	4.95	31.9	0.52	13.2
P 400 60	4.00	1.02	2.75	70	0.60	15	.025	0.6	0.63	15.9	8.94	57.7	0.60	15.2
P 797 62	7.97	2.02	6.22	158	0.62	16	0.80	2.0	0.88	22.2	39.52	254.9	0.62	15.7

(Standard part design dimensions are for reference only. There may be differences between note and actual part dimensions. Please contact DiaCom before designing hardware intended for standard parts.)

Elastomer & Fabric Data:

Fabric Data

Generally, fabric reinforcement is required when pressure differentials exceed 5 psi across the diaphragm. Some applications may require elastomeric coatings on both sides of the fabric. These materials are available from stock. Due to the many application variables, it is recommended that a DiaCom representative be consulted to ensure proper selection. The chart on page 26 lists some of DiaCom's common fabric styles, as well as some general physical characteristics of various fabric fibers.

Elastomer Data

The chart on page 27 lists common elastomers, some physical properties, and compatibility to common chemicals. Other DiaCom specialty elastomer compounds are available. These include FDA, NSF, and UL-approved compounds used in potable water, food, drug, propane and natural gas applications. Additionally, elastomeric silicone/fluorosilicone blends are available for automotive use. This is a general chart and is in no way intended as the final guide to material selection. Contact a DiaCom representative for proper elastomer selection.

Type I & ID Diaphragms

General Description:

Type I diaphragms are commonly referred to as “Involuted” diaphragms. Type I diaphragms exhibit the benefits associated with rolling diaphragms while combining ease of assembly and allowing long stroke capability.

The design of Type I rolling diaphragm provides low cost to hardware, small package size and lower assembly cost, the design offers substantial advantages over convoluted diaphragms in many applications with the overall goal in extending the life of the diaphragm.

Type I rolling diaphragms exhibit differences in both configuration and operation from Type F style diaphragms. The configuration of the sidewalls drops almost straight down from the piston diameter, then flairs out to the flange in a large corner radius.

In operation, this design’s full convolution is not present at the top and bottom of the stroke, but appears only during a portion of the piston travel.

This design provides substantial benefits because it provides the same advantages associated with an F-Style and will allow the hardware size to be reduced and is easier and less expensive to install since it is not required to form the convolution before the Type-I diaphragm is installed.

The effective pressure area of the Type I diaphragm will remain constant as long as the diaphragm remains in full convolution. However as the diaphragm rolls out of full convolution at both ends of the stroke, there will be some variation in effective pressure area.

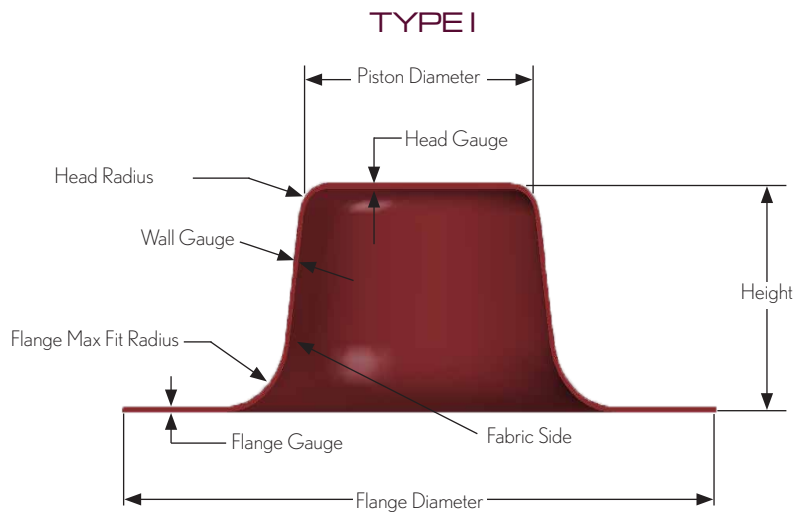

Cylinder Diameter	.25 to .99	6 to 25	1.00 to 2.50	25 to 64	2.51 to 4.00	64 to 102	4.01 to 8.00	102 to 205	8.01 & Up	205 & Up
Height	See available sizes table.									
Cylinder Diameter	Tolerances on Cylinder Diameter and Piston Diameter are $\pm .010$ " per inch of diameter, but the tolerance will be no less than $\pm .060$ ".									
Piston Diameter	Tolerances on Cylinder Diameter and Piston Diameter are $\pm .010$ " per inch of diameter, but the tolerance will be no less than $\pm .060$ ".									
Head Thickness & Flange Thickness	.015 \pm .003	0.38 \pm 0.08	.017 \pm .004	0.43 \pm 0.10	.024 \pm .004	0.61 \pm 0.10	.035 \pm .005	0.89 \pm 0.13	.045 \pm .007	1.14 \pm 0.18
Wall Gauge	.015 \pm .003	0.38 \pm 0.08	.017 \pm .004	0.43 \pm 0.10	.024 \pm .004	0.61 \pm 0.10	.035 \pm .005	0.89 \pm 0.13	.045 \pm .007	1.14 \pm 0.18
Piston Radius	.094	2.39	.125	3.18	.156	3.96	.250	6.35	.250	6.35
Flange Radius	Max fit radii allowable in hardware.									
Flange Diameter	Cyl. Diam. +.750	Cyl. Diam. +19.05	Cyl. Diam. +1"	Cyl. Diam. + 25.40	Cyl. Diam. +1.50	Cyl. Diam. +38.10	Cyl. Diam. +2"	Cyl. Diam. +50.80	Cyl. Diam. +2"	Cyl. Diam. +50.80

Hole Spacing for Type I and ID Diaphragms:

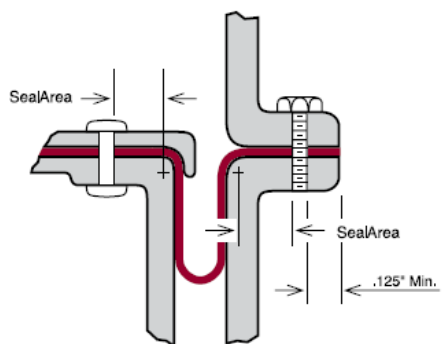

Maximum Working Pressure (psi)/kpa	(0-50)	0-350	(51-150)	357-1050	(151-300)	1057-2100	(301-500)	2107-3500
Seal Area Minimum (Inches)	.100	2.54	.150	3.81	.200	5.08	.250	6.35

Hole Spacing:

Perforations through the head or the flange should be located so that there is at least .100 inches minimum between the edges of holes. Also, holes should be located so that there is at least .125 inches between the edge of a hole and the trim periphery. It is also important to arrange the hole pattern so that the radial distance from the edge of the hole to the start of the blend radius at either the piston head or cylinder clamp flange is at least as far as indicated in the chart above.

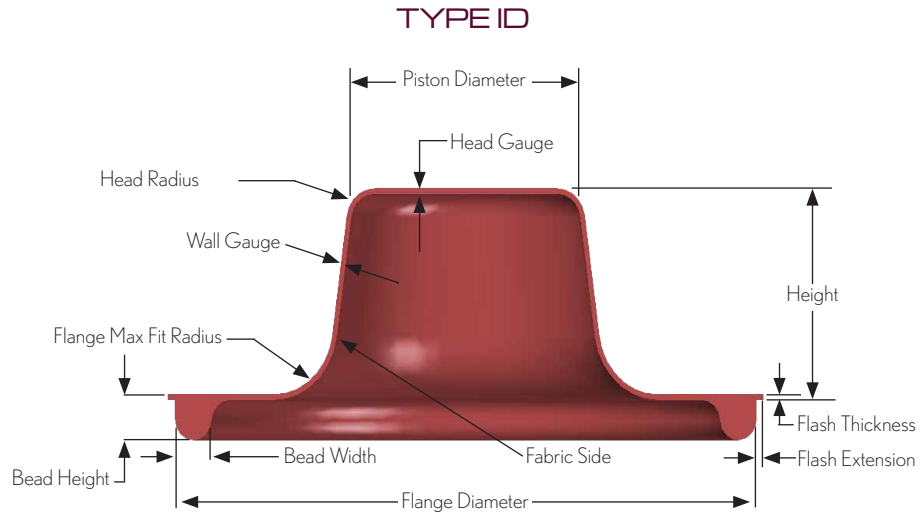

Cylinder Diameter	.07 to .99	9 to 25	100 to 2.50	25 to 64	2.51 to 4.0	64 to 102	4.01 to 8.00	102 to 205	0.01 & Up	205 & Up
Height	See available sizes table.									
Cylinder Diameter	Tolerances on Cylinder Diameter and Piston Diameter are $\pm .010$ " per inch of diameter but the tolerance will be no less than $\pm .010$ " or greater than $\pm .060$ ".									
Piston Diameter										
Head Thickness & Flange Thickness	.015 \pm .003	0.38 \pm 0.08	.017 \pm .004	0.43 \pm 0.10	.024 \pm .004	0.61 \pm 0.10	.035 \pm .005	0.89 \pm 0.13	.045 \pm .007	1.14 \pm 0.18
Wall Gauge	.015 \pm .003	0.38 \pm 0.08	.017 \pm .004	0.43 \pm 0.10	.024 \pm .004	0.61 \pm 0.10	.035 \pm .005	0.89 \pm 0.13	.045 \pm .007	1.14 \pm 0.18
Flash Projection	.025 Max	0.64 Max	.025 Max	0.64 Max	.035 Max	0.89 Max	.040 Max	1.02 Max	.056 Max	1.42 Max
Flash Thickness	.025 Max	0.64 Max	.025 Max	0.64 Max	.035 Max	0.89 Max	.040 Max	1.02 Max	.056 Max	1.42 Max
Piston Radius	.094	2.39	.125	3.18	.156	3.96	.250	6.35	.250	6.35
Flange Radius	.031	0.79	.063	1.60	.094	2.39	.125	3.18	.125	3.18
Flange Diameter	Cyl. Diam \pm .313	Cyl. Diam \pm .795	Cyl. Diam \pm .500	Cyl. Diam \pm 12.70	Cyl. Diam \pm .750	Cyl. Diam \pm 19.05	Cyl. Diam, +1"	Cyl. Diam \pm .2540	Cyl. Diam, +1"	Cyl. Diam \pm 25.40
Bead Width	.094 \pm .003	2.39 \pm 0.08	.125 \pm .003	3.18 \pm 0.08	.187 \pm .003	4.75 \pm 0.08	.250 \pm .003	6.35 \pm 0.08	250 \pm .004	6.35 \pm 0.10
Bead Height	.094 \pm .004	2.41 \pm 0.10	.135 \pm .004	3.43 \pm 0.10	.200 \pm .005	5.08 \pm 0.13	.270 \pm .007	6.86 \pm 0.18	270 \pm .008	6.86 \pm 0.20

Diaphragm Flange Diameter and Hole Trim Tolerances:					
Diameter		Size		Position	
0. - 100"	.0 - 25.40	$\pm .010$ "	0.25	.010	0.25
1.01 - 3.00"	25.65 - 76.20	$\pm .020$ "	0.51	.020	0.51
Over 3.01"	Over 76.45	$\pm .030$ "	0.76	.030	0.76
Angular relationship of holes \pm 1/2 degree.					

Hardware Recommendations:

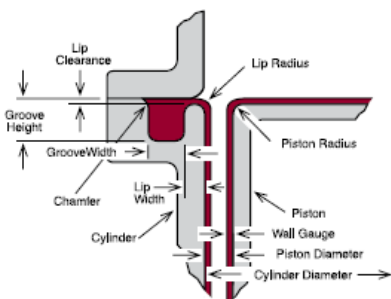

Cylinder Diameter	.25 - .99	6 - 25	100 - 2.50	25 - 64	2.51 - 4.00	64 - 102	4.01 - 8.00	102 - 205	8.01 & Up	205 & Up
Groove Width \pm .003 .008 \pm	.109	2.77	.141	3.58	.219	5.56	.281	7.14	.281	7.14
Groove Height \pm .002 .005 \pm	.076	1.93	.108	2.74	.160	4.06	.216	5.49	.216	5.49
Lip & Piston Corner Radii	.031	0.79	.063	1.60	.094	2.39	.125	3.18	.125	3.18
Lip Width \pm .004 .008 \pm	.062	1.57	.125	3.18	.187	4.75	.250	6.35	.250	6.35
Lip Clearance \pm .004 .008 \pm	.021	0.53	.021	0.53	.031	0.79	.036	0.91	.048	1.22

Typical Fabric Characteristics:

Diacom Material Designation	Color	Fabric Style	Fabric Gauge (Inches)	Fabric Gauge (mm)	Maximum Operating Temperature	Fabric Tensile Strength (lb.)	General Physical Properties
FA-0321	White	Polyester	.0031 - .0040	.0787 - .1016	302°F (150°C)	34	Light weight, special applications
FA-0503	White	Polyester	.0002 - 0.0052	.0051 - .11321	302°F (150°C)	66	Light weight, special applications
FA-0605	White	Polyester	.0048 - .0088	0.1219 - 0.2235	302°F (150°C)	64	Light weight, special applications
FA-0708	White	Polyester	.0078 - .0086	.0078 - .0086	302°F (150°C)	154	Heavy Duty, high strength
FA-0801	Black	Polyester	.0085 - .0105	.2159 - .2667	302°F (150°C)	35	Light to medium duty, good formability, knit
FA-0806	White	Polyester	.0085 - .0105	.2159 - .2667	302°F (150°C)	35	Light to medium duty, good formability, knit
FA-0919	White	Polyester	.0075 - .0095	.1905 - .2413	302°F (150°C)	80	Medium duty, good formability
FA-0920	Black	Polyester	.0075 - .0095	.1905 - .2413	302°F (150°C)	80	Medium duty, good formability
FA-1001	White	Polyester	6.008 - 0.012	0.2032 - 0.3048	302°F (150°C)	40	Knit, good formability light to medium duty
FA-1202	White	Polyester	.0088 - .0105	.2215 - 3251	302°F (150°C)	114	Medium duty, good formability
FA-1601	White	Polyester	.0140 - .0160	.3356 - 4064	302°F (150°C)	70	Medium duty, good formability
FA-2309	White	Polyester	.0223 - .0247	0.5664 - 0.6274	302°F (150°C)	390	Heavy duty, limited formability
FB-1110	Black	Nylon	.0100 - .0120	0.254 - 0.305	250°F (120°C)	290	High strength, good formability
FB-1111	White	Nylon	.0100 - .0120	0.254 - 0.305	250°F (120°C)	290	High strength, good formability
FB-2004	Black	Nylon	.0260 - .0280	0.06604 - 0.7112	250°F (120°C)	900	Heavy Duty, limited formability
FB-3701	White	Nylon	.0355 - .0395	0.9017 - 1.0033	250°F (120°C)	900	Heavy Duty, limited formability
FC-0604	Off-White	Nomex	.0068 - .0077	0.173 - 0.196	500°F (260°C)	115	High temperature, medium duty
FC-0702	Off-White	Nomex	.0073 - .0091	.1854 - .2311	500°F (260°C)	42	High temp., light to med. duty, good formability
FC-0905	Off-White	Nomex	.0084 - .0096	.2134 - .2438	500°F (260°C)	105	High temperature, medium duty
FC-1001	Off-White	Knit Aramid	.0085 - .0115	0.2159 - 0.2921	500°F (260°C)	25	Light to medium duty, knit
FC-1501	Off-White	Knit Aramid	.0130 - .0170	0.3302 - 0.4318	500°F (260°C)	42	Light to medium duty, knit
FV-100	White	Dia-Tuff	.0090 - .0130	.2286 - .3302	500°F (260°C)	600	High temperature, heavy duty, good formability

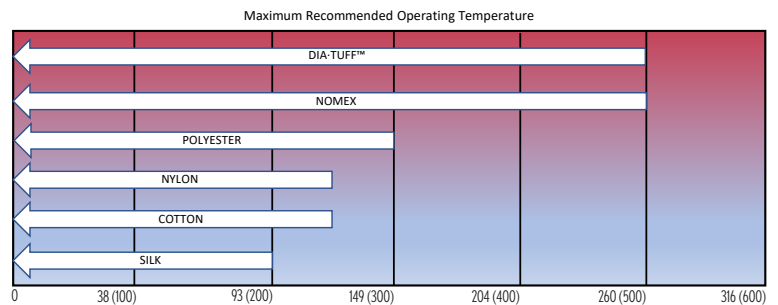

GENERAL CHEMICAL COMPATIBILITY:

	Silk	Cotton	Nylon	Polyester	Nomex	Dia-Tuff™
Property:						
Relative Tensile Strength	Moderate	Moderate	Very High	High	High	Extreme
Resistance to:						
Heat Degradation	Low	Good	Very Good	Very Good	Excellent	Excellent
Mildew	Fair	Poor-Fair	Good	Good	Excellent	Excellent
Alkalis	Poor	Good	Good	Fair	Good	Good
Weak Acids	Fair	Good	Fair	Good	Fair	Good
Strong Acids	Poor	Poor	Poor	Fair-Good	Poor	Excellent
Oxidizing Agents	Poor	Fair	Fair	Good	Poor	Excellent
Organic Solvents	Poor	Excellent	Very Good	Good	Good	Excellent
Relative Cost:	Mod-High	Moderate	Moderate	Moderate	High	Very High

The data shown in these charts and tables is based upon information from material suppliers and careful examination of available publications; and is believed to be accurate and reliable; however, it is the user's responsibility to determine suitability for use. You should thoroughly test any proposed use of our materials and independently conclude satisfactory performance in your application. For more information call the DiaCom Corporation, 5 Howe Drive, Amherst, NH 03031 - Tel. 603-880-1900

Chemical Compatibility Table:

	Butyl	Ethyl Propylene	Fluorocarbon	Fluorosilicone	Hydrin	Natural Rubber	Neoprene	Nitrile	Silicone	Styrene Butadiene
	IIR	EPDM	FKM	FVMQ	CO/ECO	NR	CR	NBR	VMQ	SBR
Physical Properties										
Compression Set Resistance	Good	Fair	Good - Excellent	Fair - Good	Fair - Good	Good	Fair - Good	Good	Good - Excellent	Good
Durometer Range (Shore A)	30 - 100	30 - 90	50 - 95	35-80	30 - 95	30 - 100	40 - 95	20 - 90	25 - 90	40 - 100
Elongation %	300 - 800	200 - 800	100 - 450	100 - 500	300 - 400	300 - 500	650 - 850	400 - 600	90 - 900	400 - 550
Tensile Strength (psi)	2,000 +	1,500 -3,000	1,500 -3,000	350 - 850	1,500 - 2000	4,000 +	2,000 - 3,000	1,000 - 3,500	600 - 1,500	2,000 +
Nitrogen Permeability Resistance	Excellent	Good	Excellent	Poor	Excellent	Good	Fair	Good	Poor	Fair
Resilience										
Mechanical Resistance Properties										
Abrasion	Good	Good	Good	Fair	Fair - Good	Excellent	Good	Excellent	Poor - Excellent	Excellent
Electrical Properties - insulating	Good	Excellent	Fair	Excellent	Poor - Fair	Excellent	Fair	Fair	Excellent	Excellent
- conductive	Fair	Poor	Excellent	Poor	Excellent	Poor	Fair	Fair	Poor	Poor
Impact	Good	Good	Poor - Good	Fair	Good	Excellent	Good	Fair	Poor - Good	Excellent
Tear	Good	Poor	Poor - Good	Fair	Good	Excellent	Good	Good	Poor - Good	Fair
Temperature Resistance Properties										
Cold Temperature Flexibility	Good	Good	Fair - Good	Good	Good	Good	Fair	Good	Excellent	Good
Flame Retardance	Poor	Poor - Fair	Excellent	Outstanding	Fair	Poor	Good	Poor - Fair	Poor - Fair	Poor
Heat Aging	Good	Excellent	Outstanding	Outstanding	Excellent	Good	Good	Good	Excellent	Good
Environmental Resistance Properties										
Ozone	Good	Excellent	Outstanding	Outstanding	Excellent	Poor	Excellent	Poor	Excellent	Poor
Radiation	Fair - Good	Poor	Fair - Good	Good - Excellent	Fair	Fair - Good	Fair - Good	Fair - Good	Fair - Excellent	Good
Weather	Excellent	Excellent	Outstanding	Outstanding	Good	Fair	Excellent	Good	Excellent	Fair
Chemical Resistance Properties										
Acid - Dilute Concentration	Fair	Good - Excellent	Fair - Good	Good - Excellent	Fair - Good	Fair - Good	Good - Excellent	Fair - Good	Fair - Good	Fair - Good
Aliphatic Hydrocarbons	Poor	Poor	Excellent	Excellent	Excellent	Poor	Good	Excellent	Poor - Fair	Poor
Alkali - Dilute Concentration	Fair - Good	Good - Excellent	Good - Excellent	Good - Excellent	Fair - Good	Fair - Good	Good - Excellent	Good - Excellent	Good - Excellent	Fair - Good
Aromatic Hydrocarbons	Poor	Poor	Excellent	Good - Excellent	Excellent	Poor	Fair	Fair - Good	Poor	Poor
ATF Type A	Poor	Poor	Excellent	Excellent	Good	Poor	Good	Excellent	Good	Poor
Chlorinated Hydrocarbons	Poor	Poor	Excellent	Good - Excellent	Good - Excellent	Poor	Poor	Fair - Good	Poor	Poor
Diesel Oil	Poor	Poor	Excellent	Good	Excellent	Poor	Fair	Good - Excellent	Poor	Poor
Di-Ester Lubricants	Poor	Poor	Excellent	Excellent	Good	Poor	Poor	Fair - Good	Poor	Poor
Ethyl Alcohol	Fair	Good - Excellent	Excellent	Excellent	Good	Good	Excellent	Good	Excellent	Fair
Ethylene Glycol	Excellent	Excellent	Excellent	Excellent	Excellent	Good - Excellent	Excellent	Excellent	Excellent	Good
Ethylene Glycol/Water	Fair - Good	Good	Good	Good	Fair	Fair - Good	Good	Good	Excellent	Good
Gasoline	Poor	Poor	Excellent	Excellent	Good - Excellent	Poor	Fair	Good - Excellent	Poor	Poor
Hydraulic Fluids - Petroleum Base	Poor	Poor	Excellent	Excellent	Excellent	Poor	Poor - Fair	Fair - Good	Poor	Poor
- Silicate Ester	Fair	Poor	Excellent	Outstanding	Fair - Good	Poor	Good	Good	Poor	Fair - Poor
- Phosphate Ester	Good	Good	Poor	Poor	Poor	Fair - Poor	Fair	Poor	Good	Poor
Ketones	Good	Fair - Excellent	Poor	Poor	Fair	Fair - Good	Fair	Poor	Fair - Good	Good
Lubricating Oils - High Aniline	Fair	Poor	Excellent	Excellent	Excellent	Poor	Good	Good - Excellent	Good	Poor
- Low Aniline	Good	Poor	Excellent	Excellent	Excellent	Poor	Fair	Fair - Excellent	Poor - Fair	Poor
Silicone Oil	Good	Excellent	Excellent	Excellent	Excellent	Fair - Good	Excellent	Good	Poor	Good
Steam - Above 121°C (250°F)	Poor - Fair	Excellent	Fair	Poor - Fair	Poor	Poor	Fair	Fair	Poor - Fair	Poor - Fair
Water - 100°C (212°F)	Good	Excellent	Excellent	Excellent	Good	Excellent	Good	Excellent	Excellent	Excellent

The compatibility data shown in this chart is based upon information from material suppliers and careful examination of available publications and is believed to be accurate and reliable; however, it is the user's responsibility to determine suitability for use. You should thoroughly test any proposed use of our materials and independently conclude satisfactory performance in your application.

The DiaCom Advantage:

Quality Management



DiaCom's Quality Systems are certified to AS-9100 Quality Management System, an International Standard developed to assure customer satisfaction. AS-9100 uses a process approach when developing, implementing, and improving the effectiveness of a quality management system. DiaCom's "DiaTrac" system enables 100% lot traceability. SPC, FMEA's, 8-D analysis, Process Control Plans, and Process Capability Studies are routinely used in accordance with manufacturing requirements. Zero-defect sampling and continual in-process quality audits insure dimensional and material integrity.

State-of-the-Art Production Facilities

Microprocessor-controlled production presses designed specifically for the production of fabric-reinforced and homogeneous elastomeric diaphragms. Our new production presses are built with high-strength components. The microprocessors closely control the vulcanization process, thus assuring precise, repeatable control of the molding process. The result is high quality, low cost diaphragm production. DiaCom utilizes unique compression and transfer molding processes to maximize efficiencies and insure the dimensional integrity of each part.



In-House Design

Computer Aided Drafting electronically enhances DiaCom's abilities to provide accurate customer tooling designs on a timely basis. DiaCom's application engineers routinely assist customers in the design of 3-D drawings, standard, or special diaphragm. We are able to accept most popular formats of CAD drawings, including: Solid Edge, STEP, IGES, DXF and others. DiaCom uses only high strength steel for production and prototype molds. DiaCom's internal tool shop has complete CNC machining capabilities that allows for quick turnaround on prototype and production tooling.

Engineering Experience

DiaCom Engineers routinely work with our customer engineering personnel to transform application concepts first into fully functioning prototypes, and ultimately into production units. Our experience and background allow us to cost-effectively provide a diaphragm that meets or exceeds all customer's diaphragm expectations. Using Auto Cad drafting software, we are able to communicate electronically with our customers to accelerate the design process. Existing diaphragm applications sometimes do not perform as well as intended. Our technical staff is available as an aid to our customers to analyze performance issues, offer hardware recommendations, and to assist in root cause analysis and the implementation of permanent corrective actions.

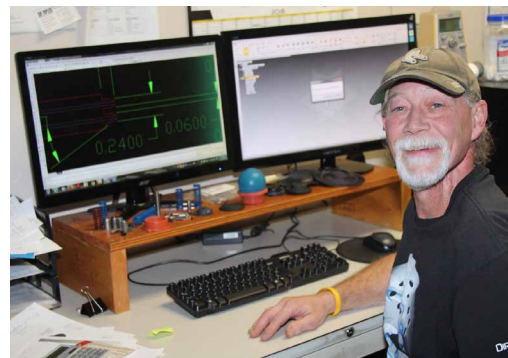

In-House Rubber Materials Laboratory

Constantly striving to improve existing applications, meeting the demands of new programs, and trouble shooting application issues, DiaCom has established a Rubber Materials Lab that gives us significant rubber testing capabilities. Using ASTM standard procedures, we are able to obtain physical properties, such as, tensile strength, elongation, modulus, durometer, tear strength, compression set, and rheology data, such as viscosity, cure times, scorch date and etc. We are also capable of running a variety of chemical compatibility testing: heat aging, volume swells, et cetera using ASTM standard testing procedures, and we can run customer-specific tests. DiaCom can custom formulate materials to meet virtually any application environment. Combining this test capability with our technical expertise allows us to provide materials that meet customer specifications, ASTM material call-out and other certification bodies, such as UL or NSF.

Diaphragm Seals

Application Data Form

Thank you for your request for engineering assistance. Answers to the following questions will provide our Engineering department with information to assist in the analysis of your specific application. Please make sure to provide as much information as available. Where possible, please provide prints, layouts, or sketches of the proposed diaphragm and installation.

Type of mounting		Inches	Cylinder Bore Diameter		Inches
Piston Diameter		Inches	Height		Inches
Up-Stroke		Inches	Minimum Operating Temperature		°F
Down-Stroke*		Inches	Normal Operating Temperature		°F
Total Stroke		Inches	Maximum Temperature		°F
Minimum Pressure		Psi	Time Interval at High Temperature:		
Normal Pressure		Psi			
Maximum Pressure**		Psi	* Stroke as measured from Flange		
Reverse Pressure		Psi	** Operating and Surge		
Pressure Differential:		Psi			

Fluid or gas in contact with Diaphragm on High Pressure Side: _____

Fluid or Gas in contact with Diaphragm on Low Pressure Side: _____

Estimated # of Cycles Required for Satisfactory Performance: _____ Approximate Cycle Rate: _____

Trim & Perforation Requirements: _____

Submit sketch or drawing if special trim/perforation requirements.)

Annual Quantity Requirements: _____ Delivery/Release Requirements: _____

Customer Part or Print Number: _____

(If this is a current production part, please indicate any quality or performance problems you are encountering. If appropriate, submit a sample part for Engineering evaluation.)

Please list any special requirements or environmental considerations not listed above: _____

Please Print Below:

Date: _____

Name: _____

Title: _____

Company: _____

Phone: _____

Street Address: _____

Email: _____

City: _____ State: _____

Country: _____

Diaphragm Design & Manufacturing Leader

DiaCom Corporation, an ISO 9001 and AS9100 certified company, is a recognized leader in the design, manufacture and application of innovative, high performance molded diaphragm seals. DiaCom serves a variety of markets worldwide including industrial, automotive, aerospace, food processing, water controls, medical instrumentation, appliances and others. DiaCom offers state-of-the-art diaphragms designed for cost effectiveness, ease of installation, durability and high performance characteristics.

 **DIA.COM CORPORATION**
The Diaphragm Company
Online Guidebook: www.diacom.com



5 Howe Drive Amherst, NH 03031 USA

Phone: 800.632.5681 603.880.1900 Fax: 603.880.7616

Internet: www.diacom.com Email: sales@diacom.com

The information shown is based upon information from material suppliers and careful examination of available publications and is believed to be accurate and reliable; however, it is the user's responsibility to determine suitability for use. You should thoroughly test any proposed use of our materials and independently conclude satisfactory performance in your application.

Molded Diaphragms - Ideal solutions to tough sealing problems.

DIA·COM
CORPORATION
The Diaphragm Company

Corporate Headquarters:

5 Howe Drive Amherst, NH 03031 USA

Phone (US Only): 800.632.5681 603.880.1900 Fax: 603.880.7616

Internet: www.diacom.com Email: sales@diacom.com

The information contained herein is believed to be reliable, but no representations, guarantees or warranties of any kind are made as to its accuracy, suitability for particular applications or the results to be obtained therefrom. Nothing contained herein is to be considered as permission, recommendation, nor as an inducement to practice any patented invention without permission of the patent owner.